

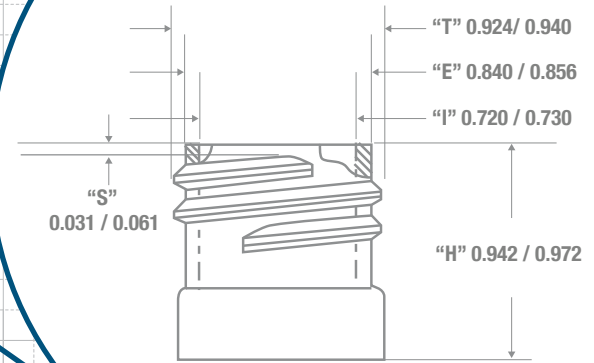

NECK & THREAD DETAIL



FRONT VIEW

SIDE VIEW

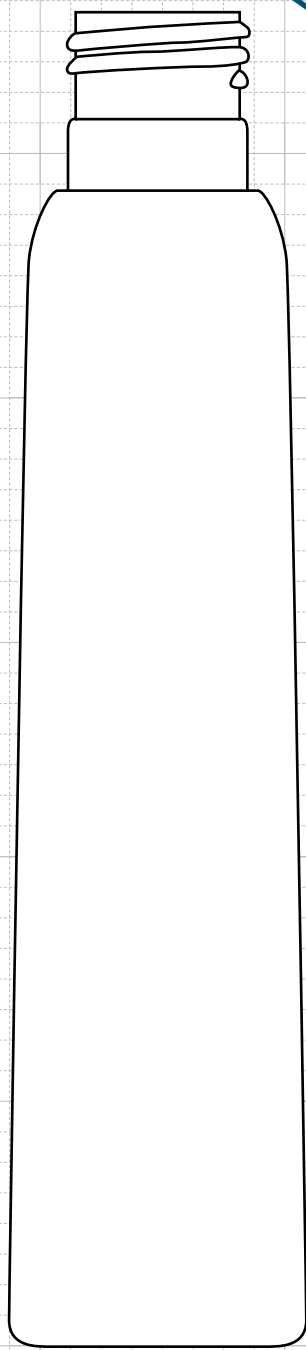
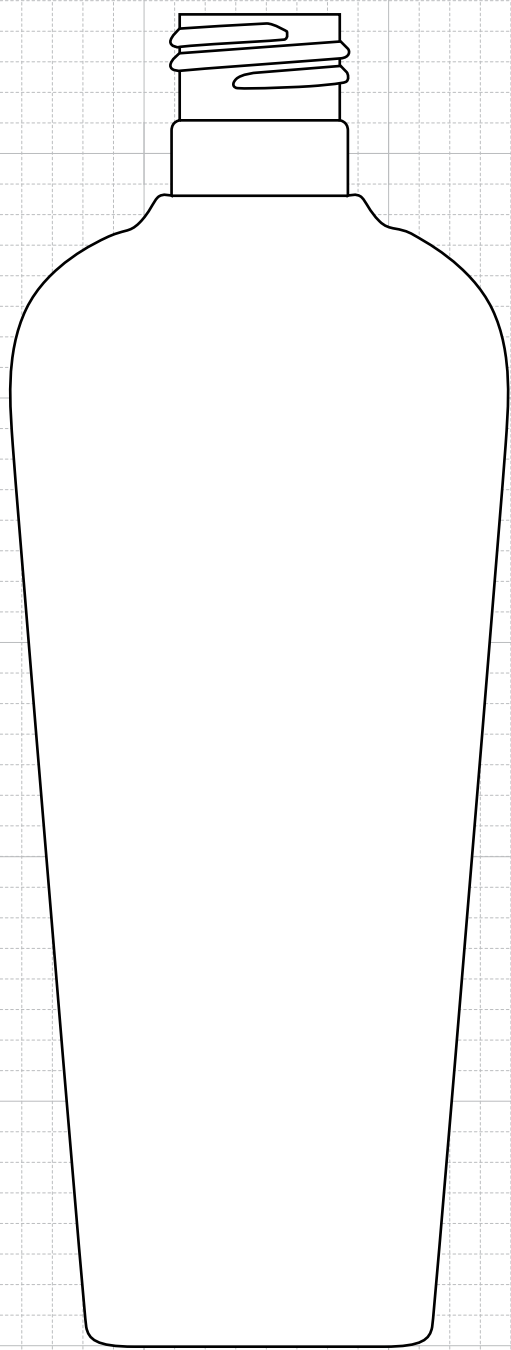

B

B

A

C

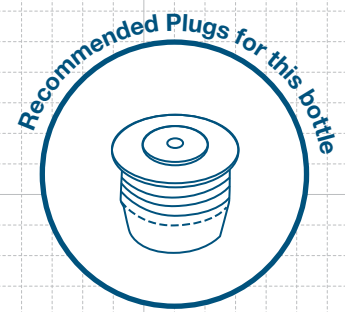

FRICITION FIT

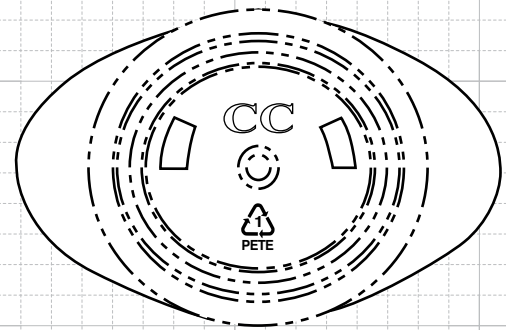

BOTTOM VIEW



CLASSIC CONTAINERS INC
 1700 S. Hellman Ave.
 Ontario, CA 91761
 Phone: 909-930-3610
 e-mail: info@classiccontainers.com
 www.classiccontainers.com

Drawing: 8 oz Vail Oval 24/415	Gram Weight: 23 ± 1	Max Print Area (Height): 4.500"	Cases Per Pallet: 16
Stock Code: 000800100251700	Neck Finish: 24/415	Max Print Area (Width): Shoulder: 1.500" Base: 1.000"	Box Dimensions: 24 7/16 x 18 1/2 x 23
Manufacturing Process: Stretch Blow Molding	Base Width (A) 1.850 ± 0.050 Base Deep (C): 1.680 ± 0.050	Case Pack: 375	Stock Material:
Overflow Capacity: 242 - 260 ml (8.2 - 8.8 oz)	Overall Height (B): 6.950 ± 0.050	Case Weight (lb): 22.0 ± 0.8	Rev #2 01/2016 Drawing not exactly to size.

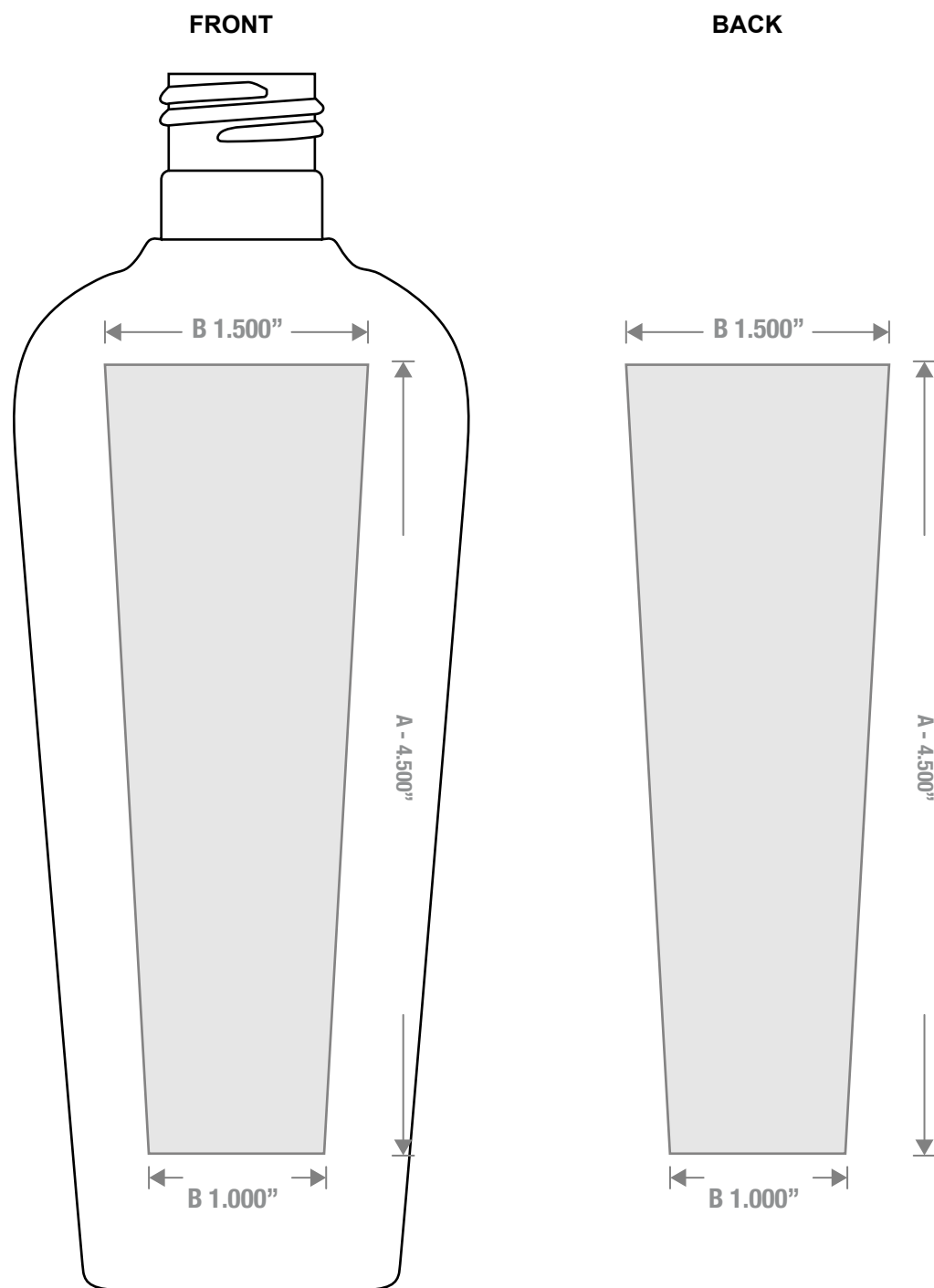

FRONT

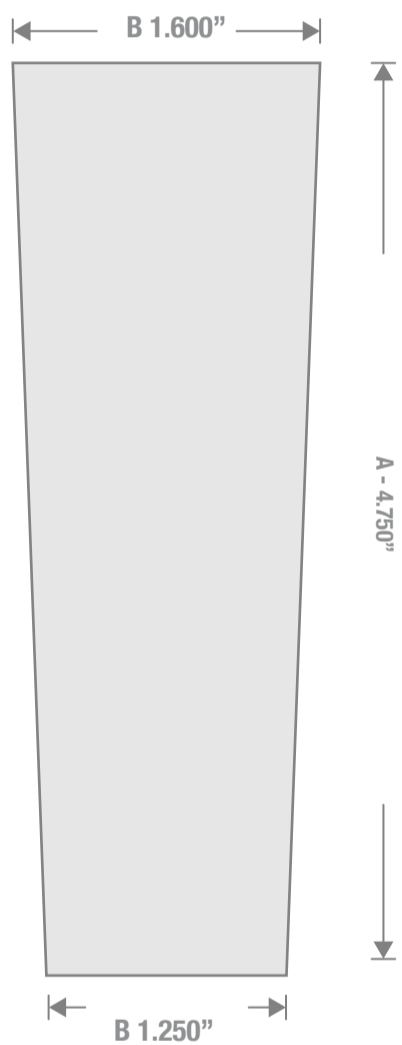

BACK

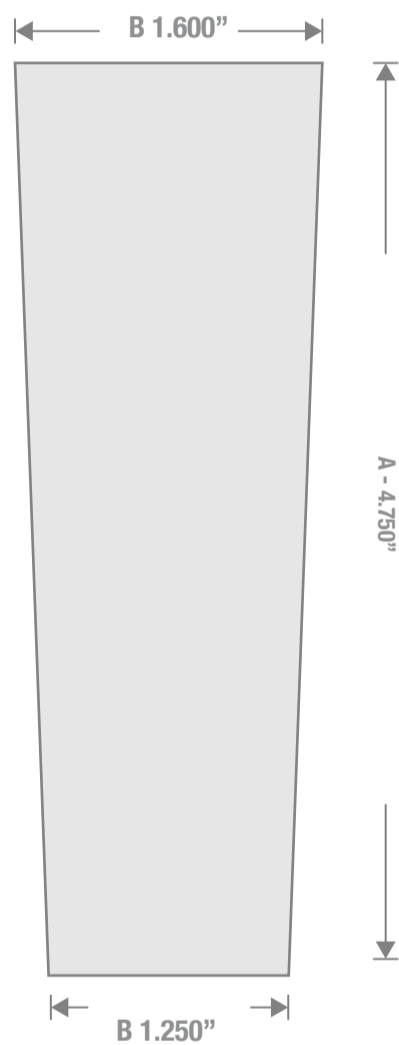

1700 S Hellman Ave, Ontario, California 91761
Phone: (909) 930-3610 | Fax: (909) 930-3640
e-mail: info@classiccontainers.com
www.classiccontainers.com

A - Total Height.
B - Max. Decorating Area.