

**NECK & THREAD DETAIL**

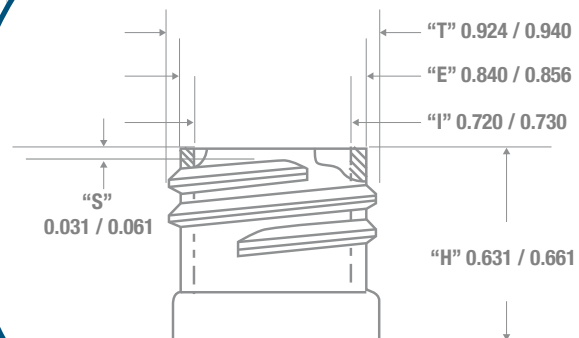

**FRONT VIEW**

**SIDE VIEW**

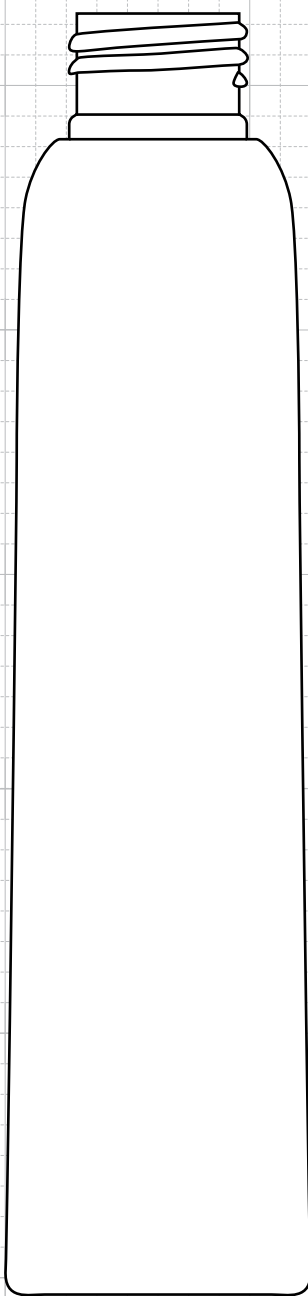
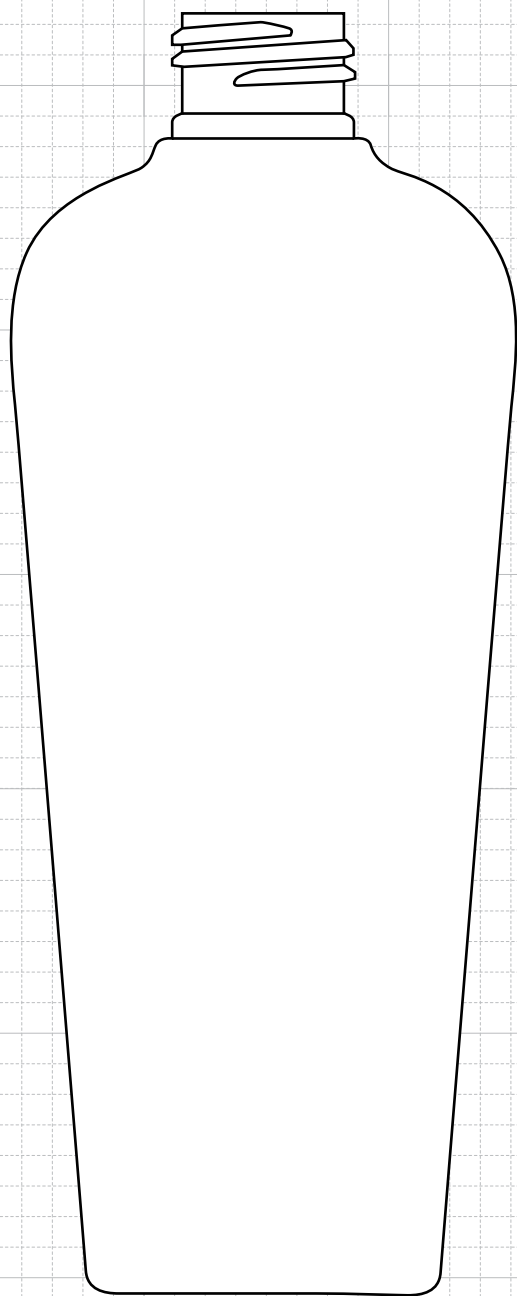

B

A

C



**FRICITION FIT**

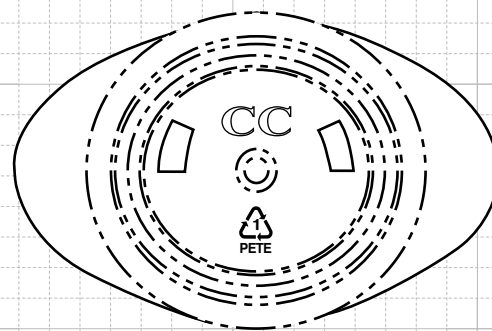

**BOTTOM VIEW**



**CLASSIC CONTAINERS INC**  
 1700 S. Hellman Ave.  
 Ontario, CA 91761  
 Phone: 909-930-3610  
 e-mail: info@classiccontainers.com  
 www.classiccontainers.com

Drawing:  
**8 oz Vail Oval 24/410**

Gram Weight:  
**23 ± 1**

Max Print Area (Height):  
**4.500"**

Cases Per Pallet: **16**

Stock Code:  
**000800100241700**

Neck Finish:  
**24/410**

Max Print Area (Width):  
 Shoulder: **1.500"** Base: **1.000"**

Box Dimensions:  
**24 7/16 x 18 1/2 x 23**

Manufacturing Process:  
**Strech Blow Molding**

Base Width (A) Base Deep (C):  
**1.850± 0.050 1.680± 0.050**

Case Pack: **375**

Stock Material:



Overflow Capacity:  
**239 - 257 ml (8.1 - 8.7 oz)**

Overall Height (B):  
**6.660 ± 0.050**

Case Weight (lb): **22.0 ± 0.8**

Rev #2 01/2016

Drawing not exactly to size.

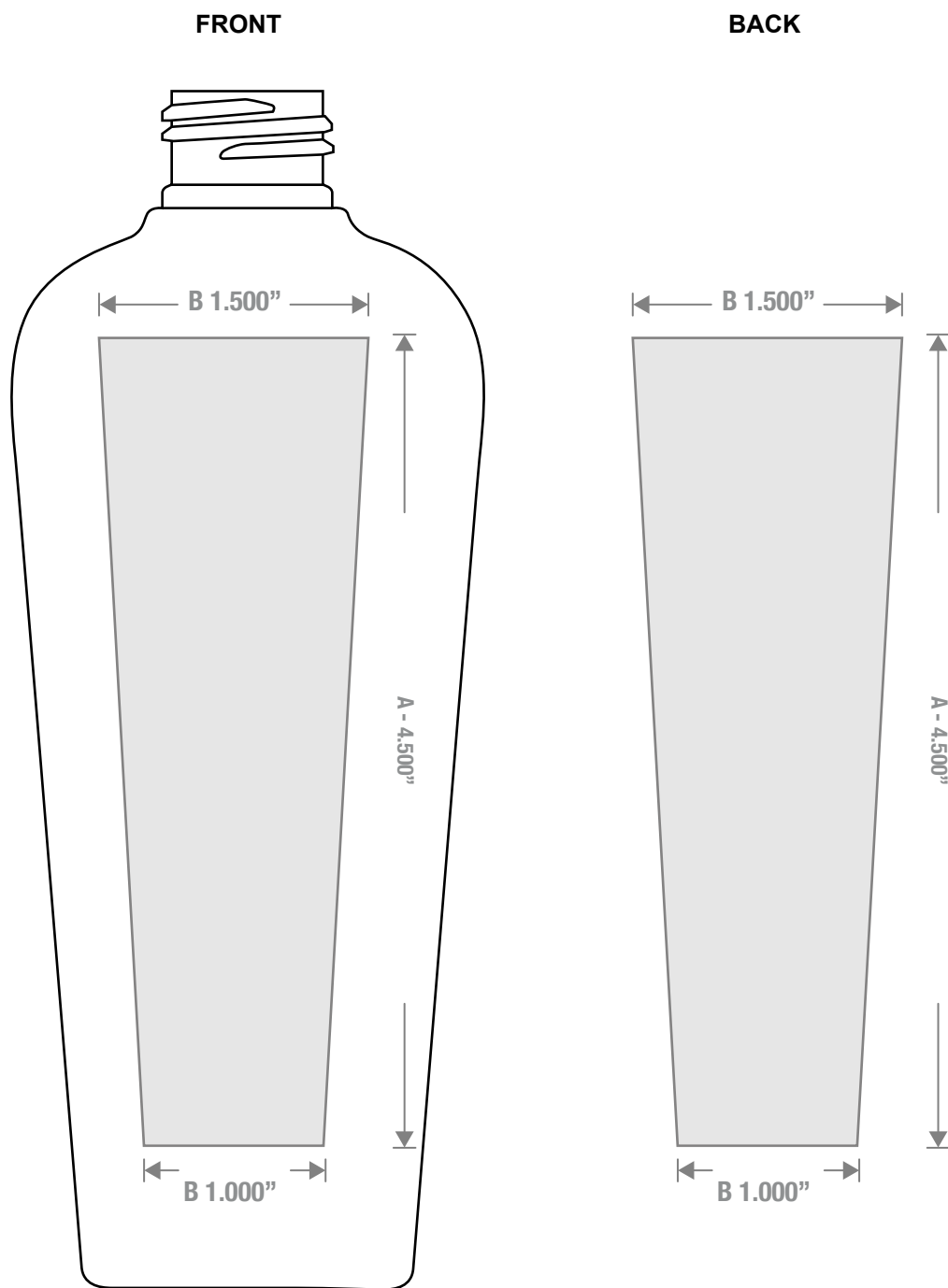

FRONT

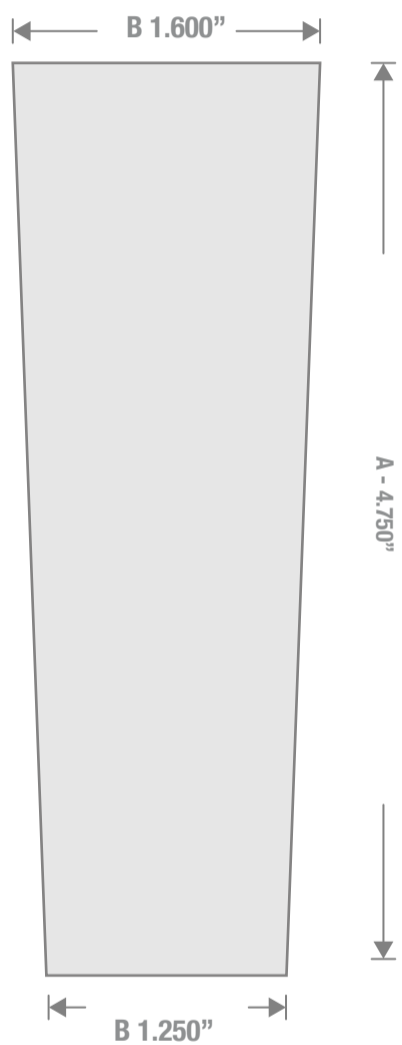

BACK

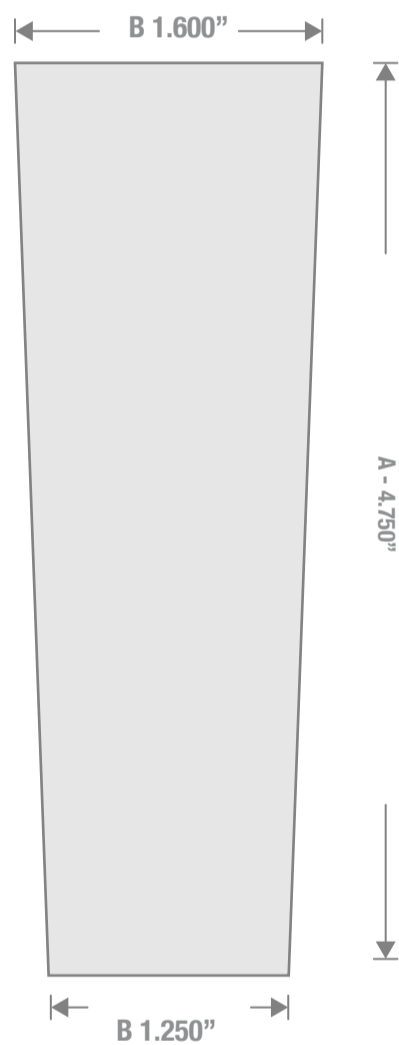

**LASSIC  
CONTAINERS  
Inc.**

1700 S Hellman Ave, Ontario, California 91761  
Phone: (909) 930-3610 | Fax: (909) 930-3640  
e-mail: [info@classiccontainers.com](mailto:info@classiccontainers.com)  
[www.classiccontainers.com](http://www.classiccontainers.com)

A - Total Height.  
B - Max. Decorating Area.