

NECK & THREAD DETAIL

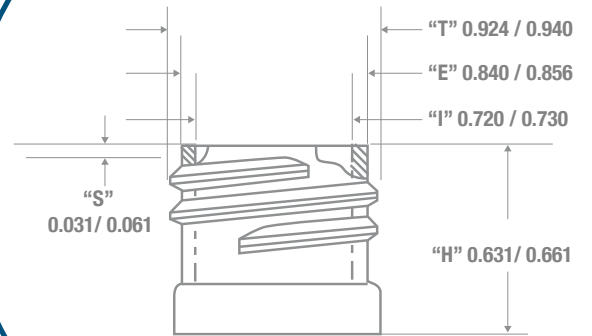

FRONT VIEW

SIDE VIEW

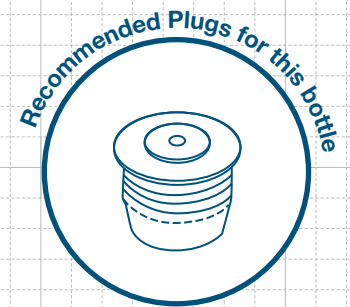
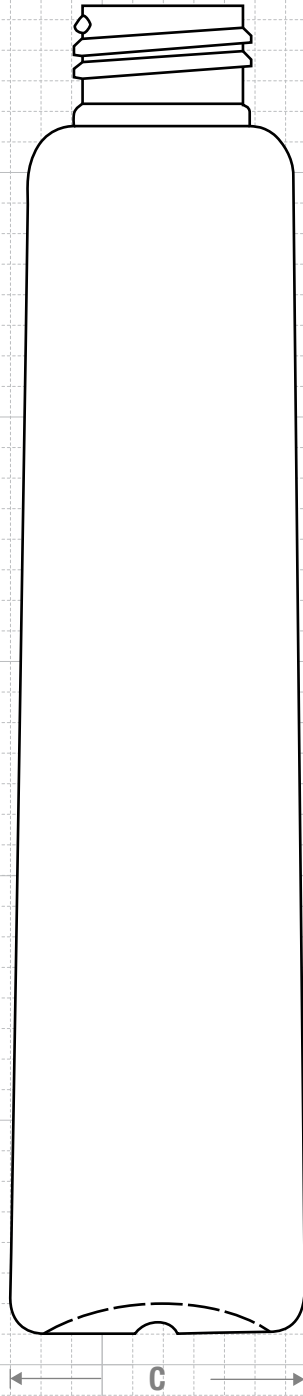
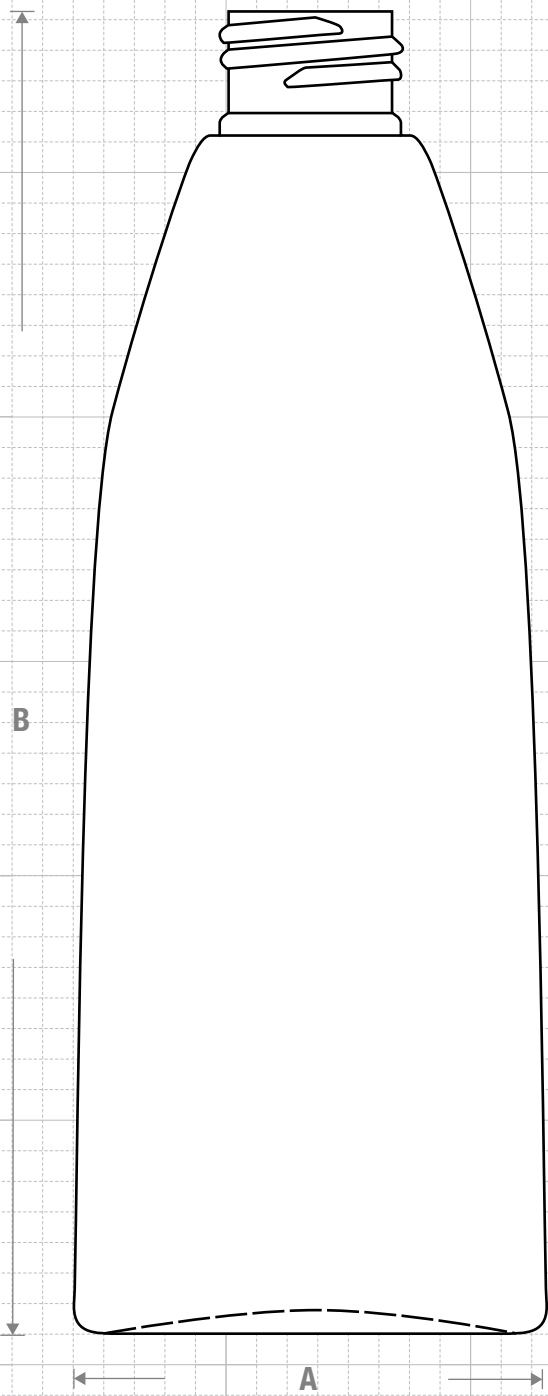

FRICTION FIT

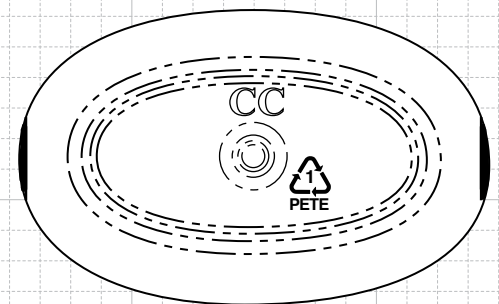

BOTTOM VIEW



CLASSIC CONTAINERS INC
 1700 S. Hellman Ave.
 Ontario, CA 91761
 Phone: 909-930-3610
 e-mail: info@classiccontainers.com
 www.classiccontainers.com

Drawing:
8 oz Teardrop 24/410

Gram Weight:
23 ± 1

Max Print Area (Height):
4.900"

Cases Per Pallet: **16**

Stock Code:
000800350241700

Neck Finish:
24/410

Max Print Area (Width):
 Shoulder: 1.000" Base: 1.650"

Box Dimensions:
24 7/16 x 18 1/2 x 23

Manufacturing Process:
Stretch Blow Molding

Base Width (A) Base Deep (C):
2.450± 0.050 1.580± 0.050

Case Pack: **377**

Stock Material:



Overflow Capacity:
245 - 263 ml (8.3 - 8.9 oz)

Overall Height (B):
6.910 ± 0.050

Case Weight (lb): **22.0 ± 0.8**

Rev #2 01/2016

Drawing not exactly to size.

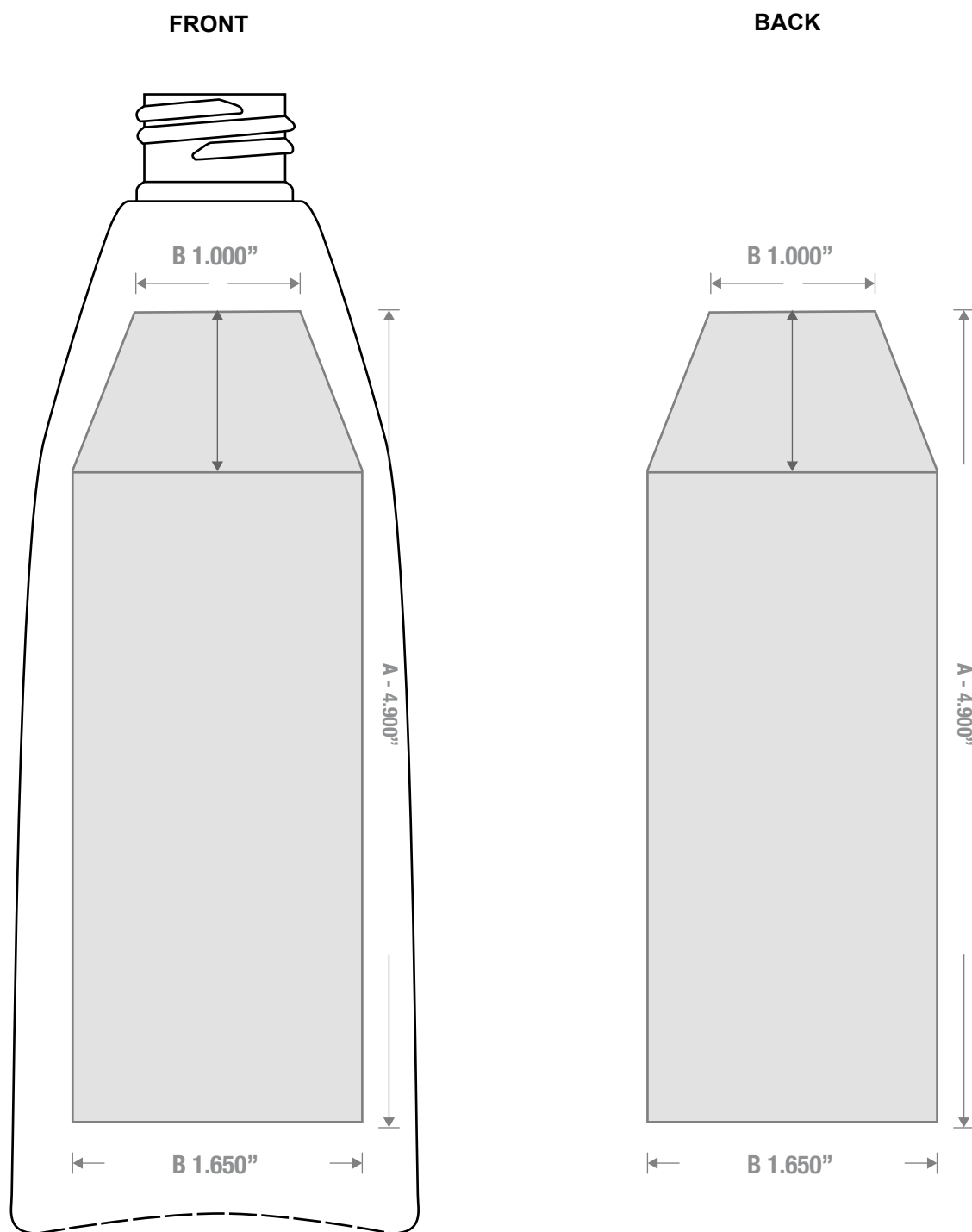

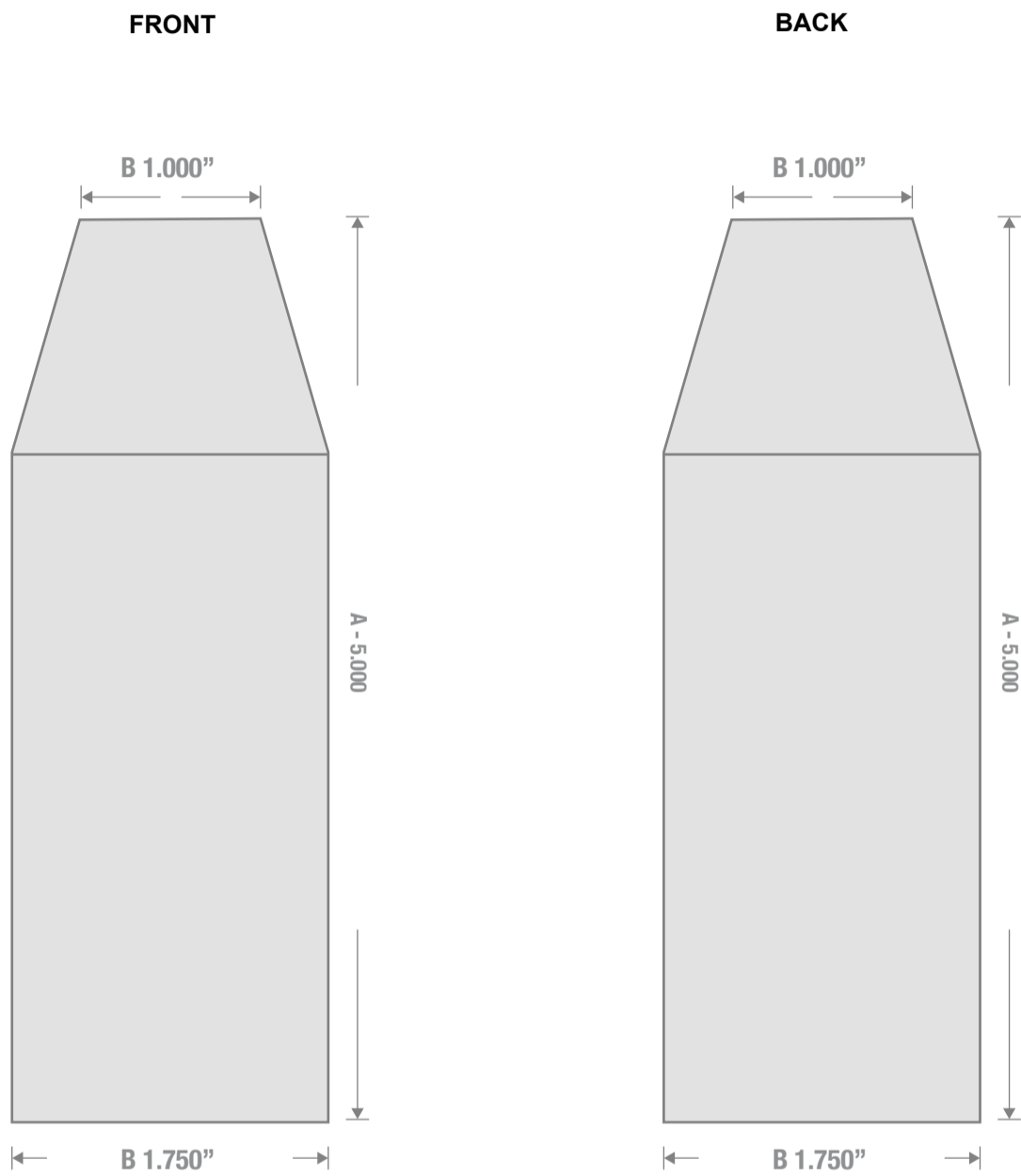

1700 S Hellman Ave, Ontario, California 91761
Phone: (909) 930-3610 | Fax: (909) 930-3640
e-mail: info@classiccontainers.com
www.classiccontainers.com

A - Total Height.
B - Max. Decorating Area.