

NECK & THREAD DETAIL

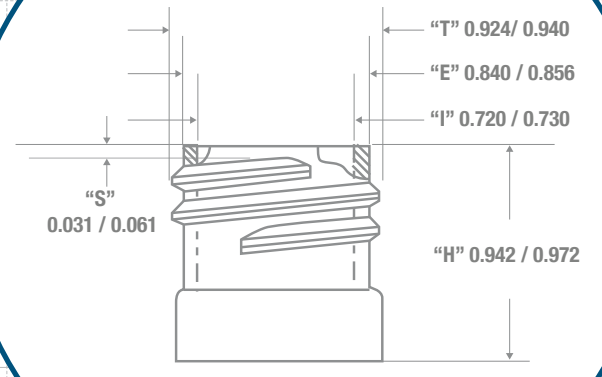

FRONT VIEW

SIDE VIEW

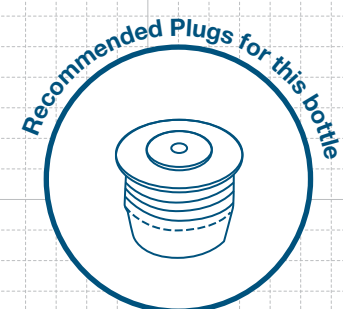
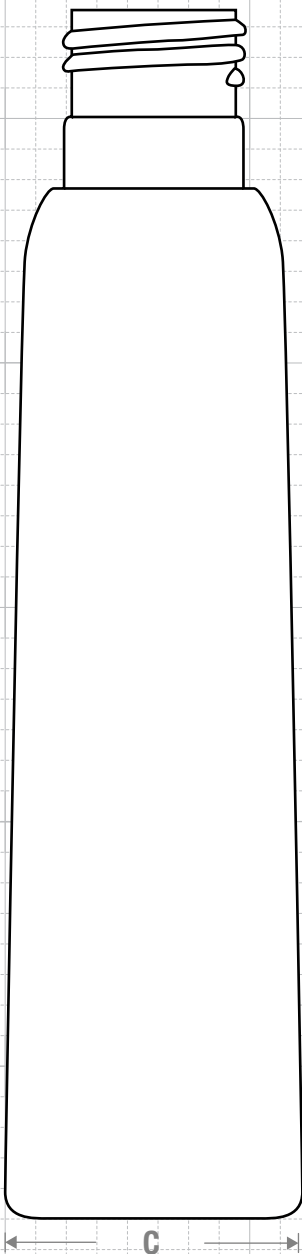
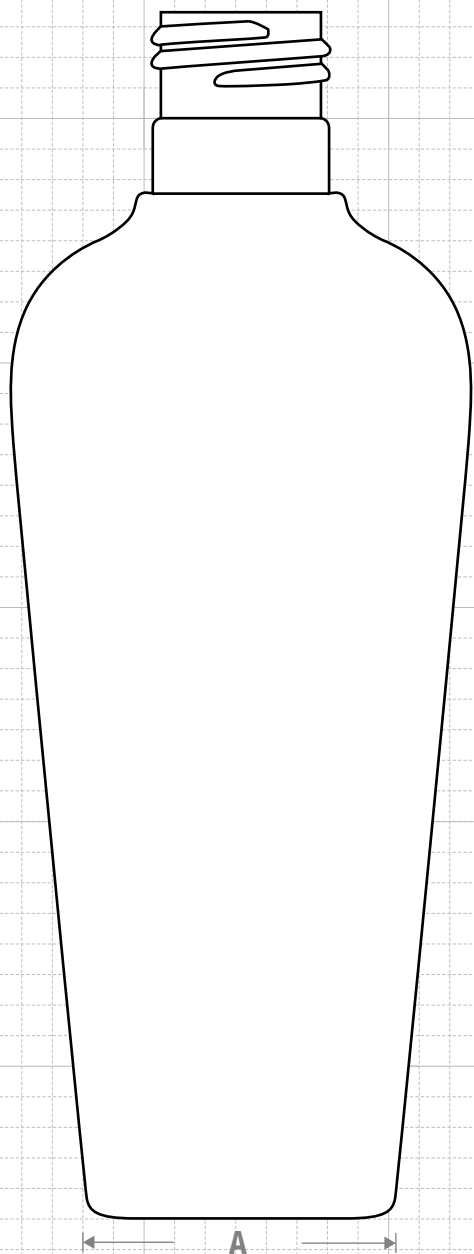

Recommended Plugs for this bottle

FRICTION FIT

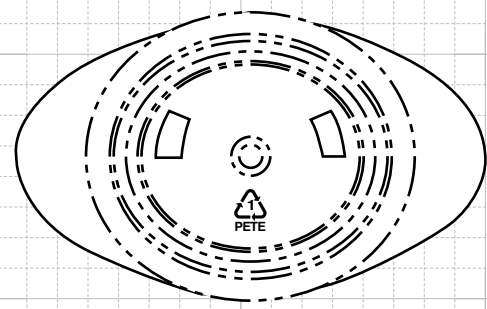

BOTTOM VIEW



CLASSIC CONTAINERS INC
 1700 S. Hellman Ave.
 Ontario, CA 91761
 Phone: 909-930-3610
 e-mail: info@classiccontainers.com
 www.classiccontainers.com

Drawing: 6 oz Vail Oval 24/415	Gram Weight: 20 ± 1	Max Print Area (Height): 4.000"	Cases Per Pallet: 16
Stock Code: 000600100251700	Neck Finish: 24/415	Max Print Area (Width): Shoulder: 1.453" Base: 0.875"	Box Dimensions: 24 7/16 x 18 1/2 x 23
Manufacturing Process: Stretch Blow Molding	Base Width (A) Base Deep (C): 1.630 ± 0.050 1.550 ± 0.050	Case Pack: 486	Stock Material:
Overflow Capacity: 192 - 204 ml (6.5 - 6.9 oz)	Overall Height (B): 6.280 ± 0.050	Case Weight (lb): 24.4 ± 1.0	Rev #2 01/2016 Drawing not exactly to size.

FRONT

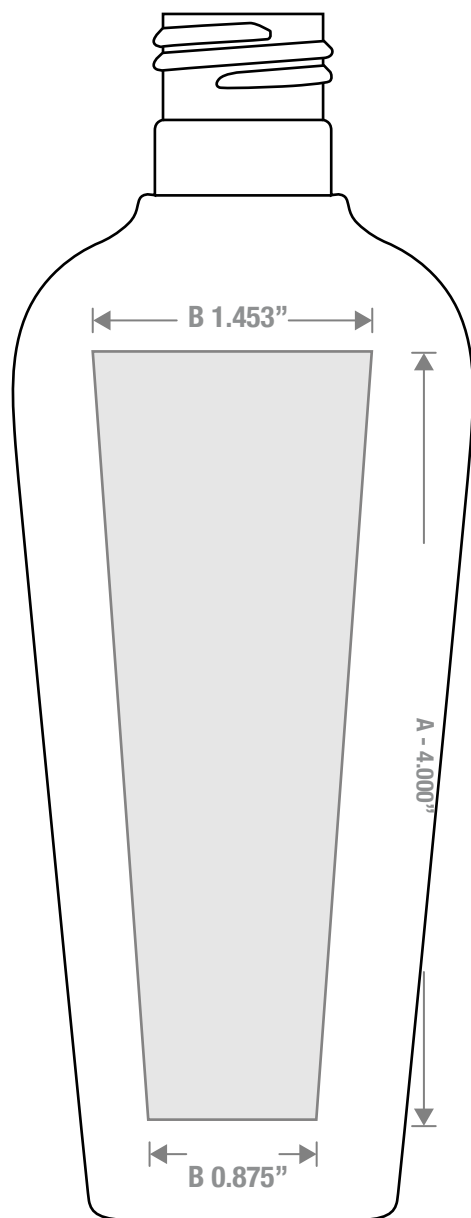

BACK

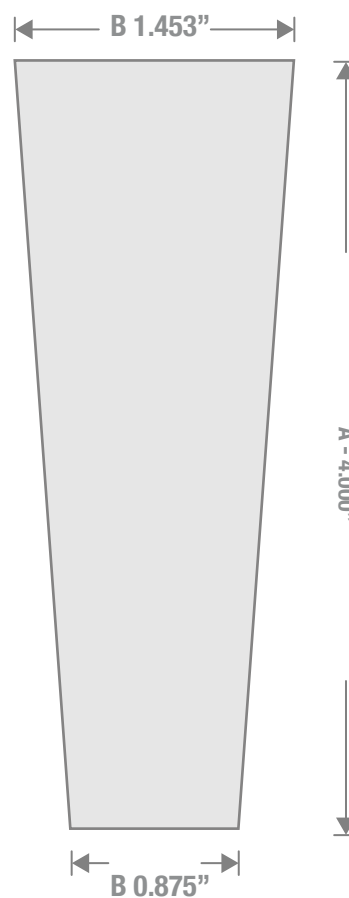

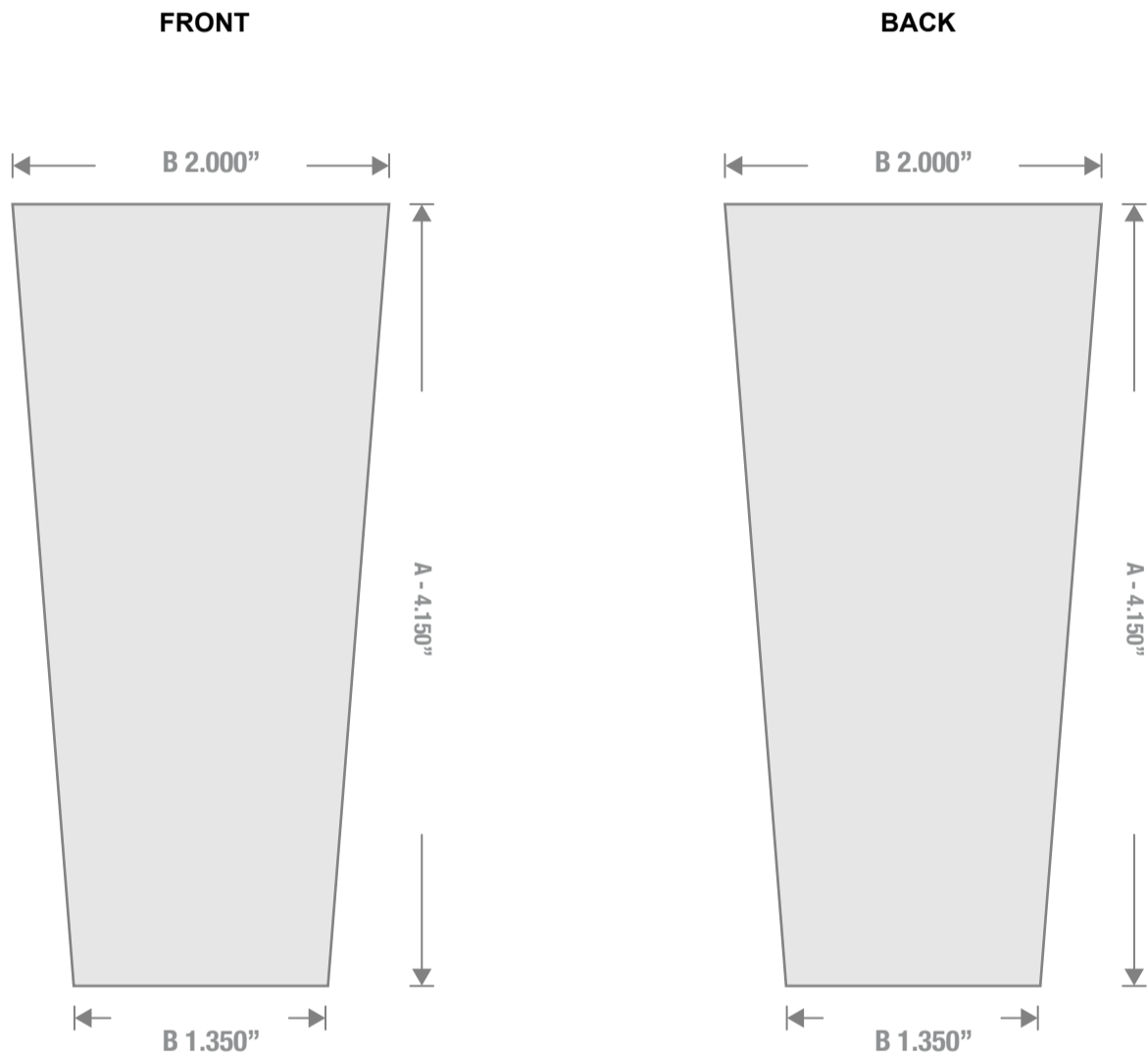

1700 S Hellman Ave, Ontario, California 91761
Phone: (909) 930-3610 | Fax: (909) 930-3640
e-mail: info@classiccontainers.com
www.classiccontainers.com

A - Total Height.
B - Max. Decorating Area.