

NECK & THREAD DETAIL

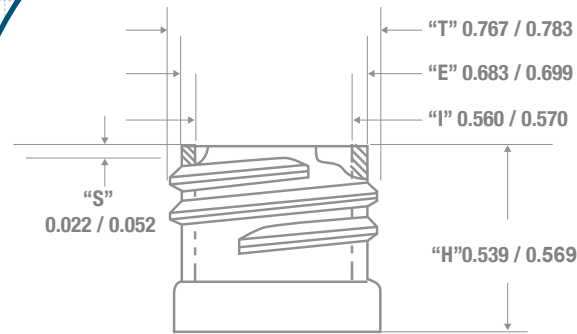

FRONT VIEW

SIDE VIEW

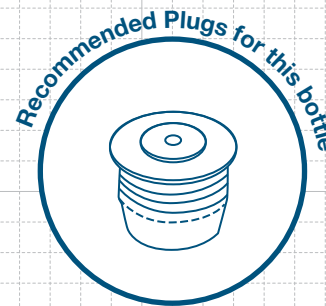
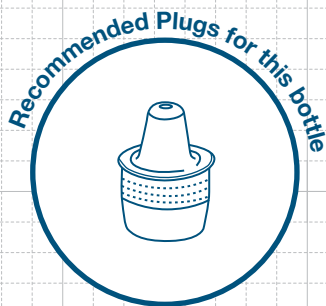
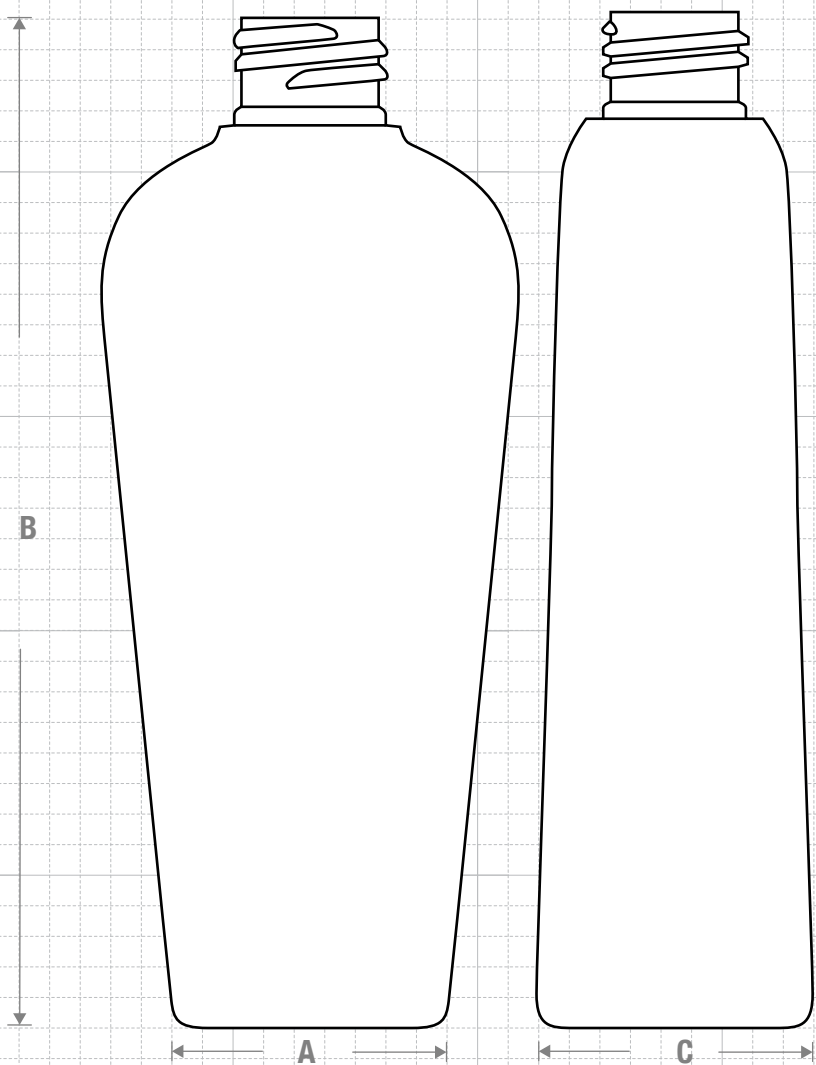

FRICTION FIT

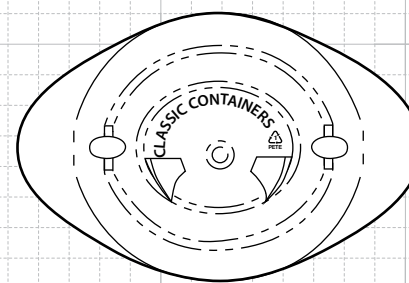

BOTTOM VIEW



CLASSIC CONTAINERS INC
 1700 S. Hellman Ave.
 Ontario, CA 91761
 Phone: 909-930-3610
 e-mail: info@classiccontainers.com
 www.classiccontainers.com

Drawing:
4 oz Vail Oval 20/410

Gram Weight:
15 ± 1

Max Print Area (Height):
3.250"

Cases Per Pallet: **25**

Stock Code:
0004000100201700

Neck Finish:
20/410

Max Print Area (Width):
 Shoulder: **1.500"** Base: **1.000"**

Box Dimensions:
23 5/8 x15 9/16 x17

Manufacturing Process:
Stretch Blow Molding

Base Width (A) Base Deep (C):
1.496± 0.050 1.406± 0.050

Case Pack: **441**

Stock Material:



Overflow Capacity:
127- 139 ml (4.3 - 4.7 oz)

Overall Height (B):
5.305 ± 0.050

Case Weight (lb): **16.7 ± 1.0**

Rev #2 01/2016

Drawing not exactly to size.

FRONT

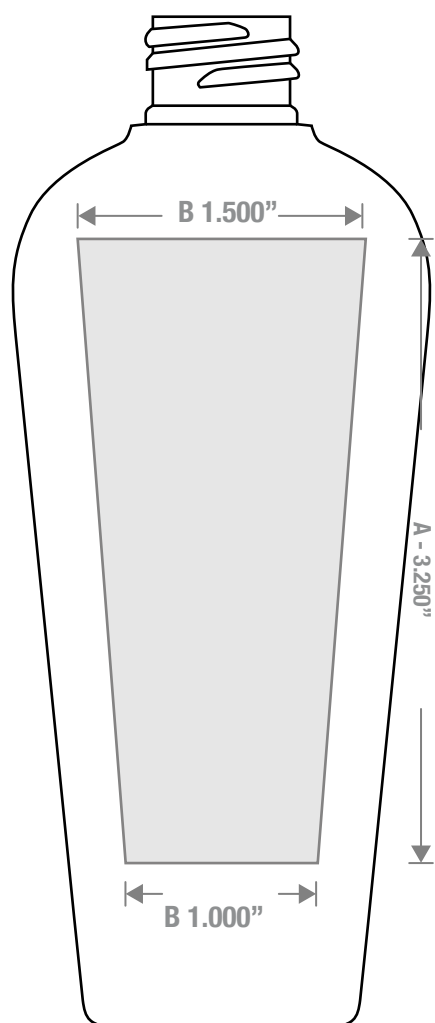

BACK

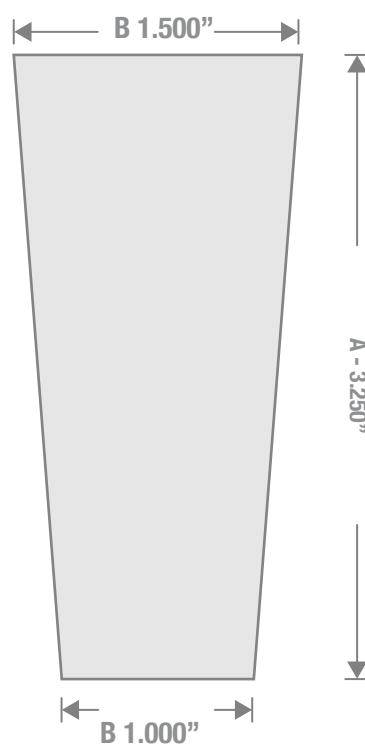

FRONT

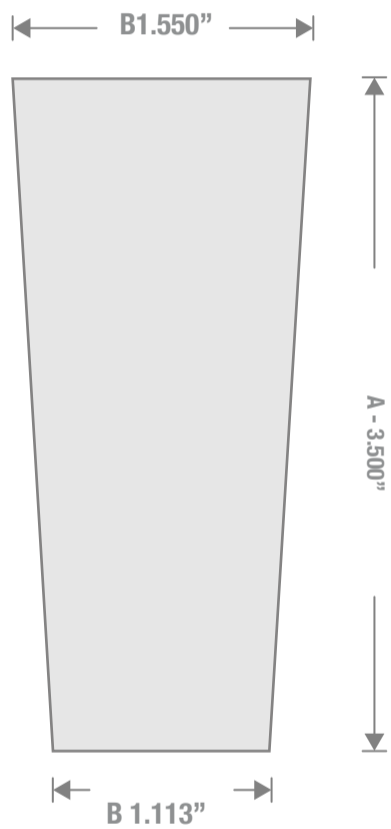

BACK

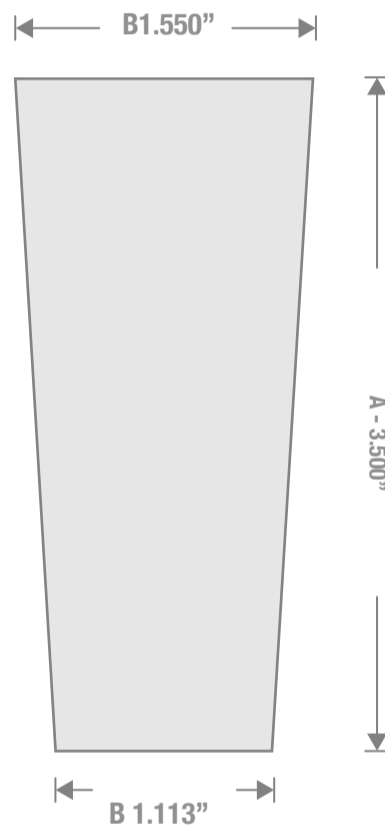

**LASSIC
CONTAINERS
Inc.**

1700 S Hellman Ave, Ontario, California 91761
Phone: (909) 930-3610 | Fax: (909) 930-3640
e-mail: info@classiccontainers.com
www.classiccontainers.com

A - Total Height.
B - Max. Decorating Area.