

NECK & THREAD DETAIL

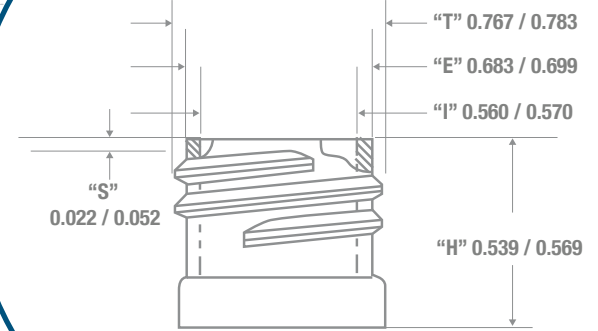

FRONT VIEW

SIDE VIEW

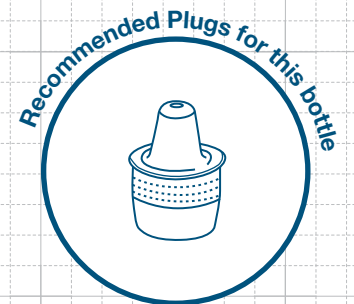
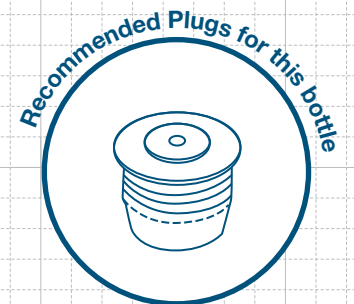
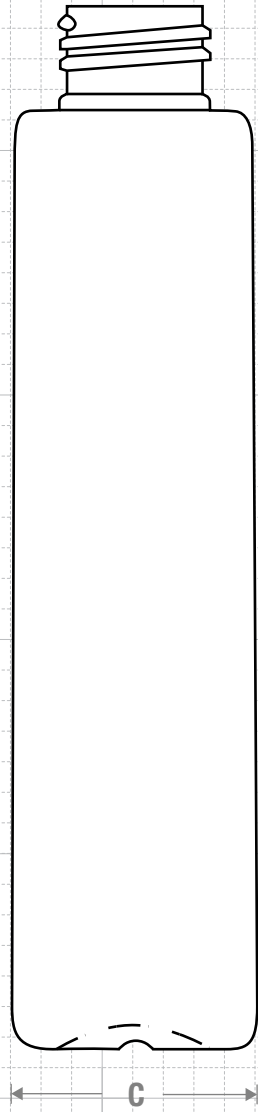
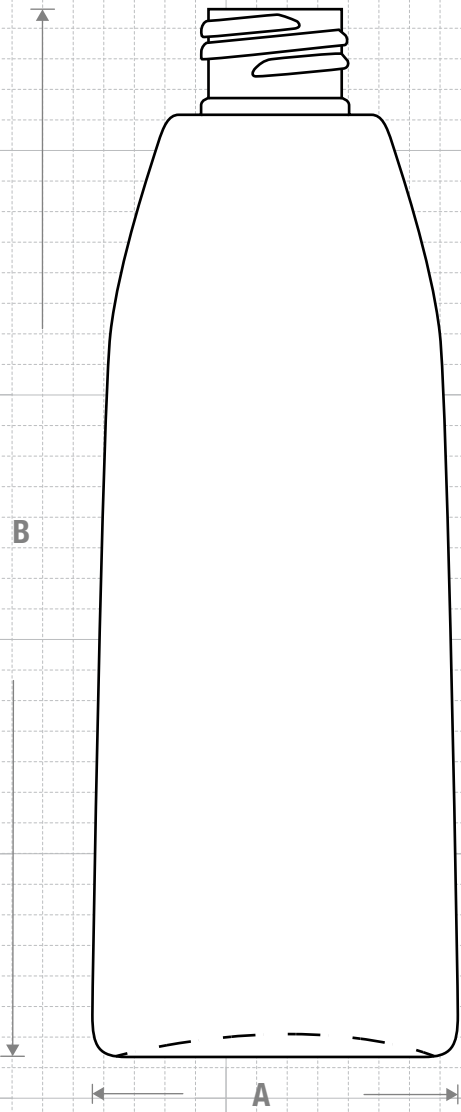

FRICITION FIT

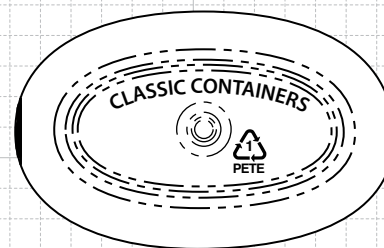

BOTTOM VIEW



CLASSIC CONTAINERS INC
 1700 S. Hellman Ave.
 Ontario, CA 91761
 Phone: 909-930-3610
 e-mail: info@classiccontainers.com
 www.classiccontainers.com

Drawing:
4 oz Teardrop 20/410

Gram Weight:
15 ± 1

Max Print Area (Height):
3.540"

Cases Per Pallet: **25**

Stock Code:
000400350201700

Neck Finish:
20/410

Max Print Area (Width):
 Base: **1.250"** Shoulder: **0.500"**

Box Dimensions:
23 5/8 x 15 9/16 x 17

Manufacturing Process:
Stretch Blow Molding

Base Width (A) Base Deep (C):
1.961± 0.050 1.291± 0.050

Case Pack: **495**

Stock Material:



Overflow Capacity:
121 - 133 ml (4.1- 4.5 oz)

Overall Height (B):
5.416 ± 0.050

Case Weight(lb): **18.5 ± 1.0**

Rev #3 02/2017

Drawing not exactly to size.

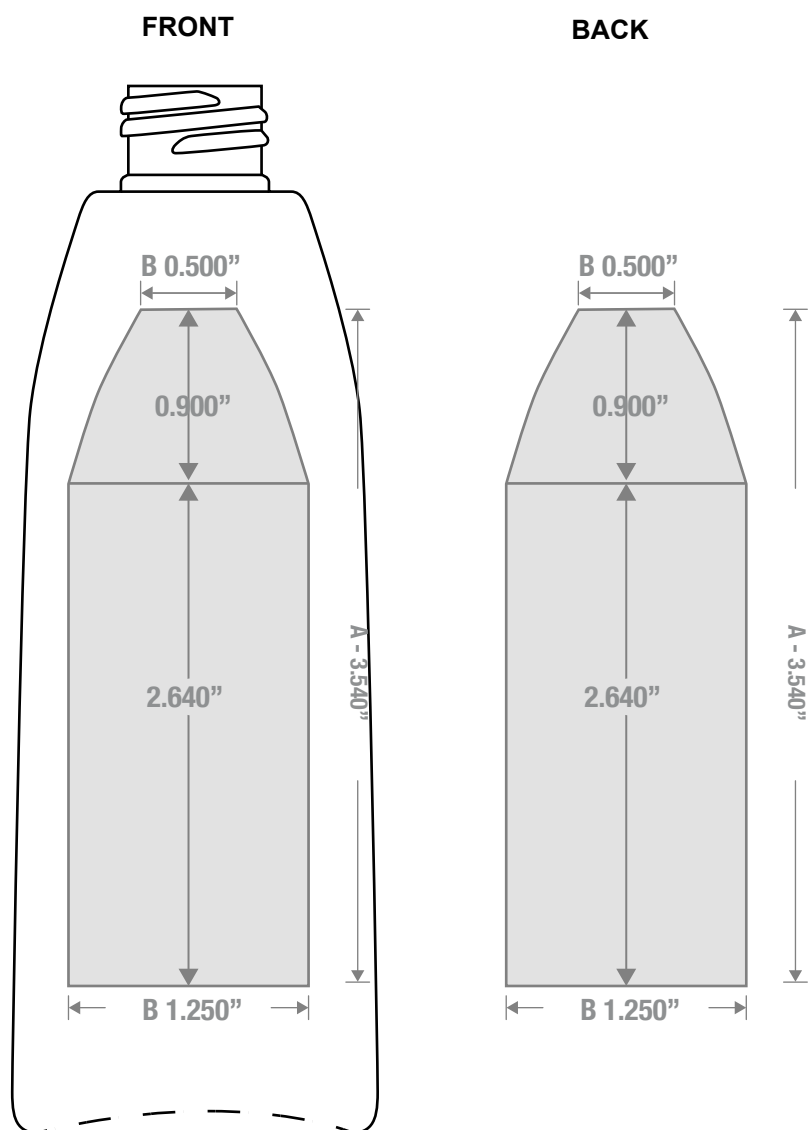

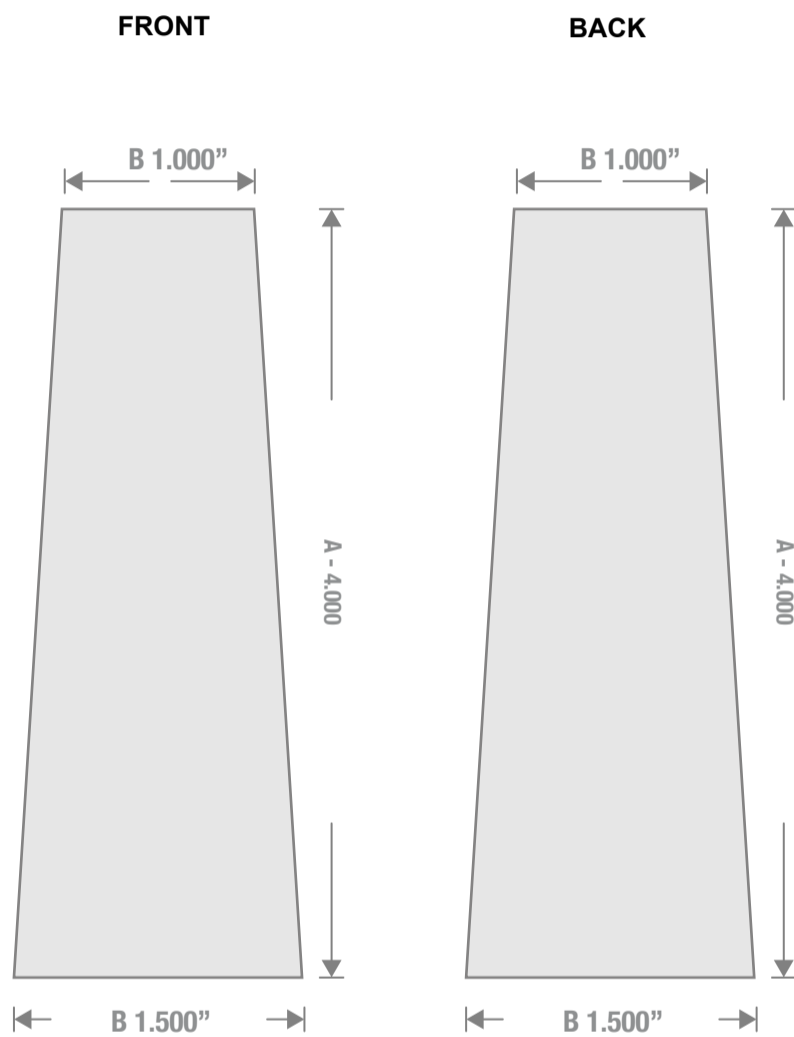

1700 S Hellman Ave, Ontario, California 91761
Phone: (909) 930-3610 | Fax: (909) 930-3640
e-mail: info@classiccontainers.com
www.classiccontainers.com

A - Total Height.
B - Max. Decorating Area.