

NECK & THREAD DETAIL

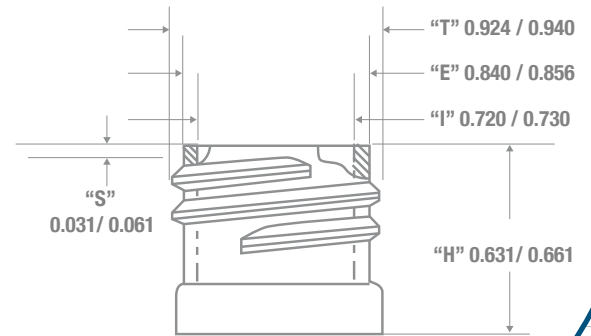

FRONT VIEW

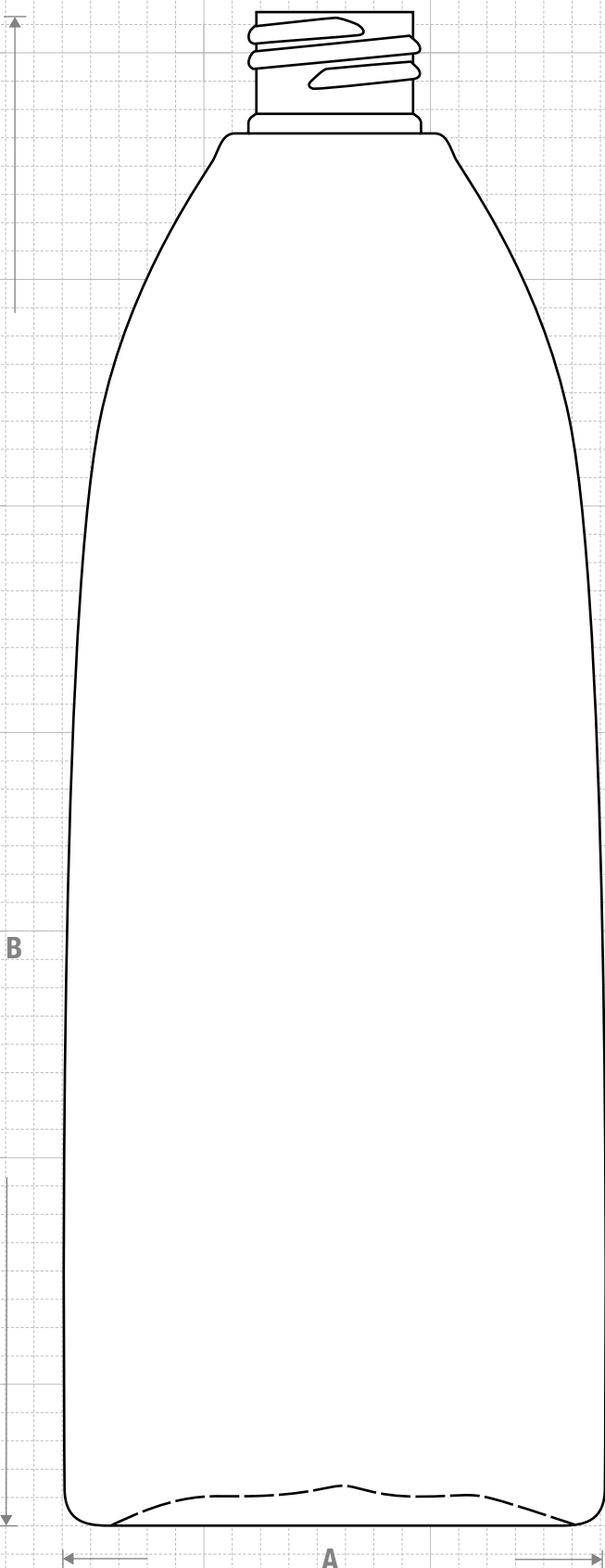

SIDE VIEW

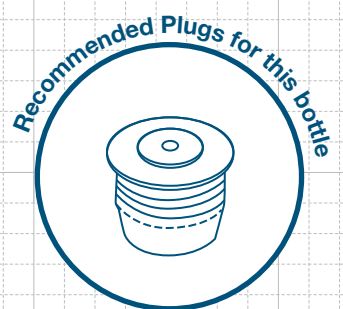
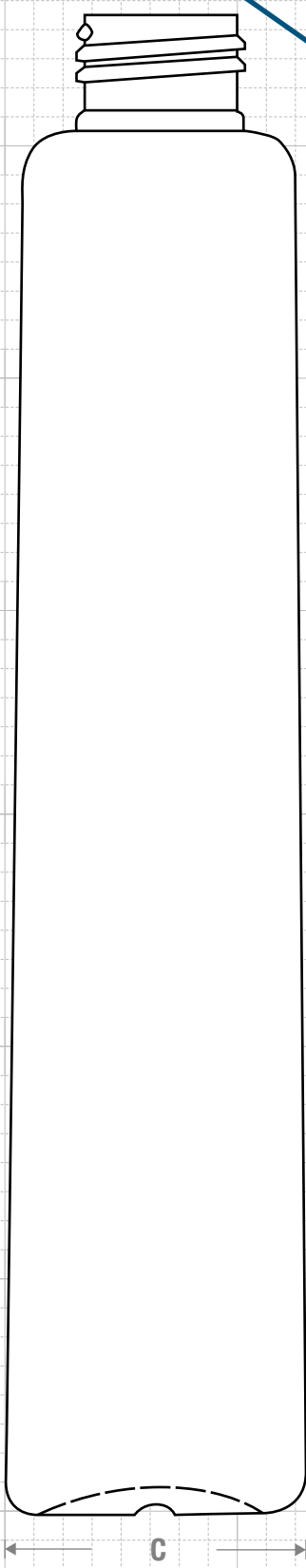

FRICITION FIT

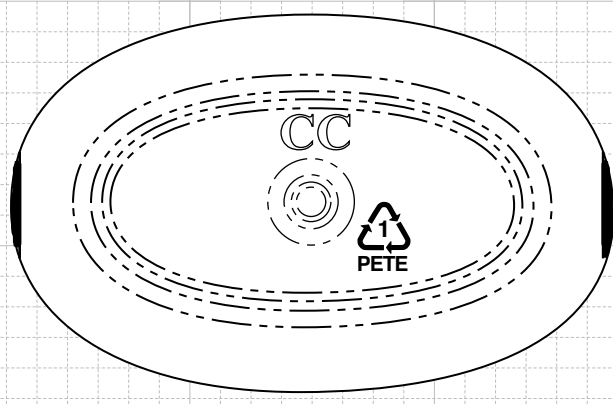

BOTTOM VIEW



CLASSIC CONTAINERS INC
 1700 S. Hellman Ave.
 Ontario, CA 91761
 Phone: 909-930-3610
 e-mail: info@classiccontainers.com
 www.classiccontainers.com

Drawing: 16 oz Teardrop 24/410	Gram Weight: 36 ± 1	Max Print Area (Height): 6.062"	Cases Per Pallet: 16
Stock Code: 001600350241700	Neck Finish: 24/410	Max Print Area (Width): Shoulder: 1.000" Base: 2.250"	Box Dimensions: 24 7/16 x 18 1/2 x 23
Manufacturing Process: Stretch Blow Molding	Base Width (A) 3.140 ± 0.050 Base Deep (C): 2.030 ± 0.050	Case Pack: 182	Stock Material:
Overflow Capacity: 504 - 528 ml (17.1 - 17.9 oz)	Overall Height (B): 8.580 ± 0.050	Case Weight (lb): 17.4 ± 0.4	Rev #2 02/2016 Drawing not exactly to size.

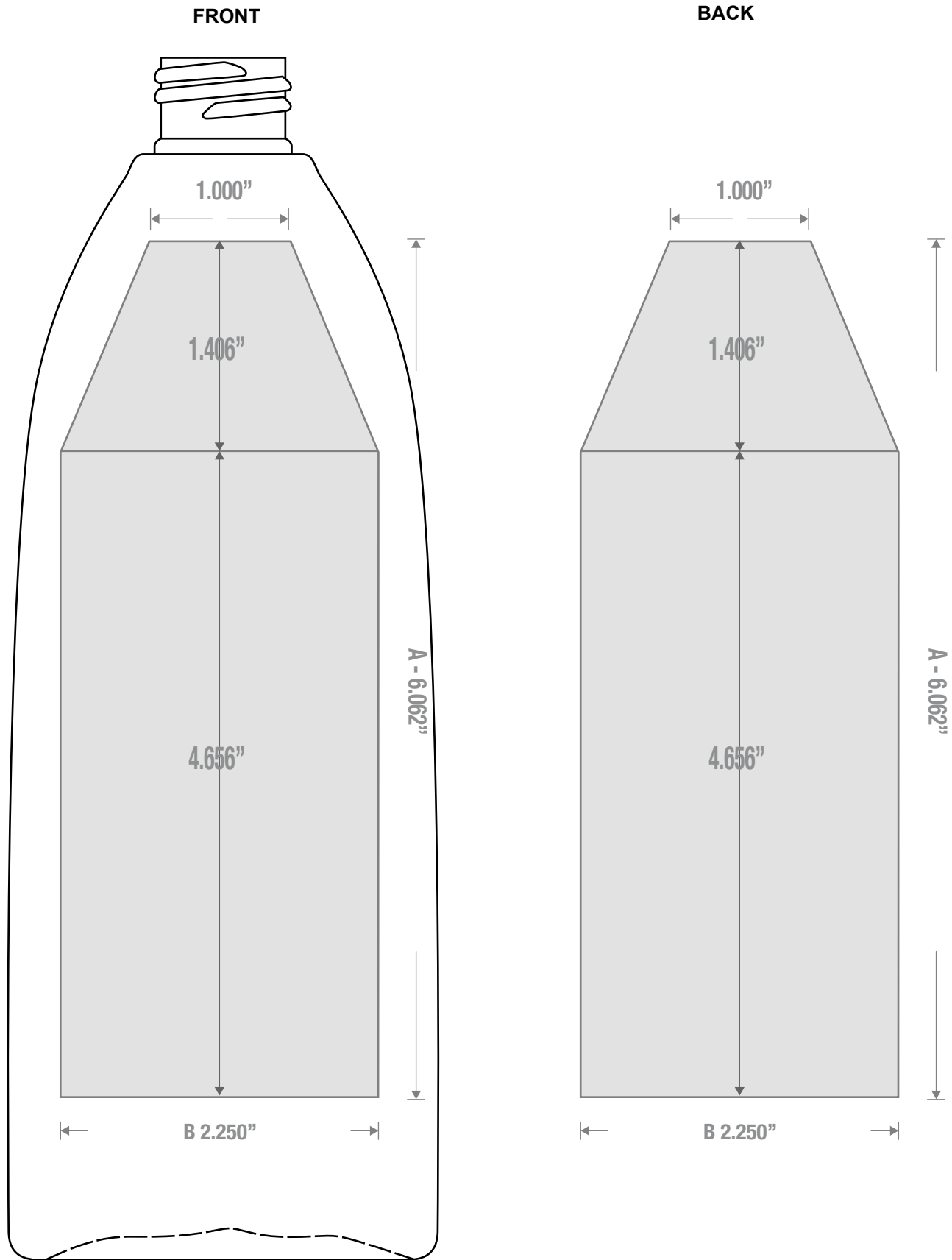

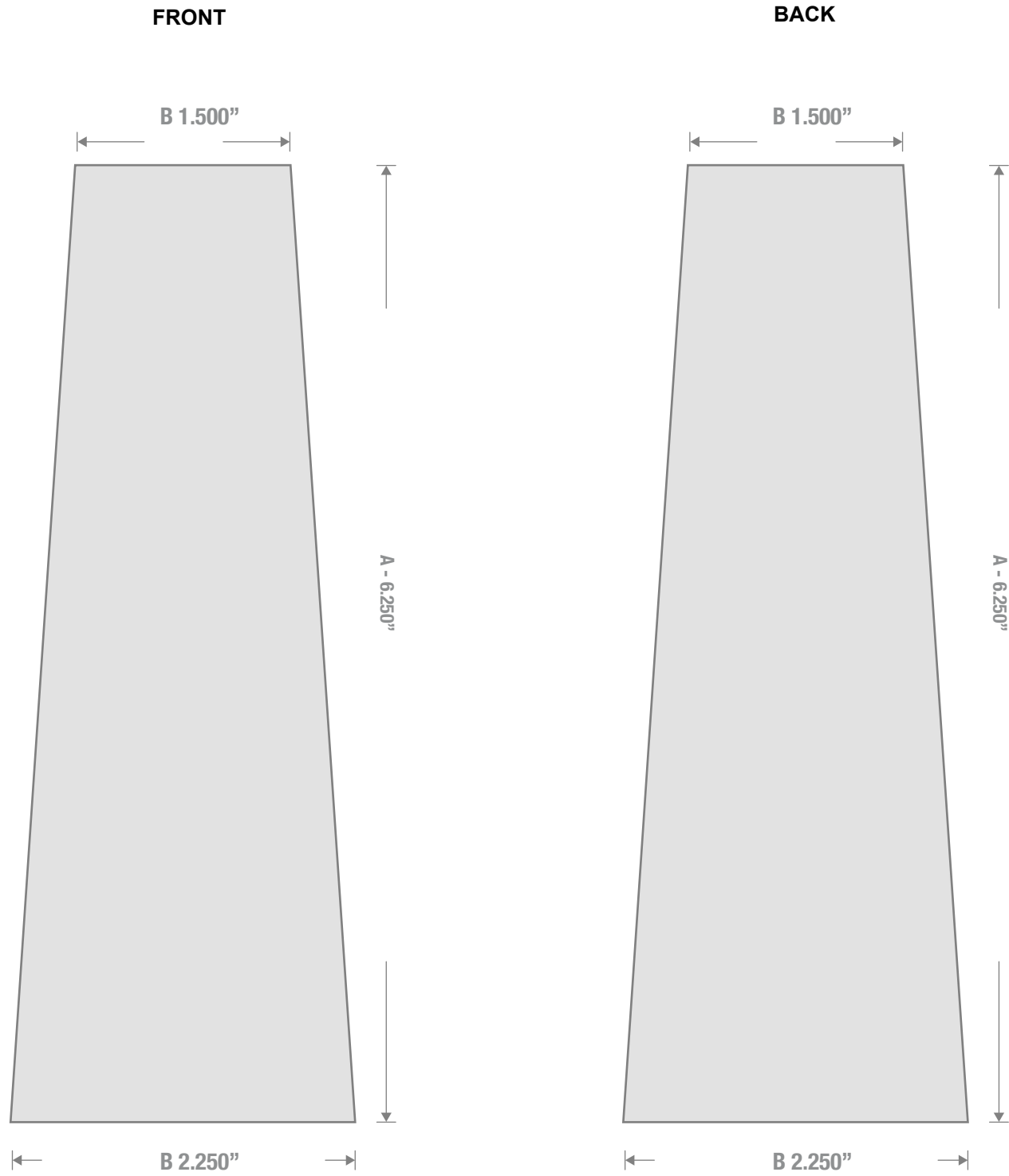

1700 S Hellman Ave, Ontario, California 91761
Phone: (909) 930-3610 | Fax: (909) 930-3640
e-mail: info@classiccontainers.com
www.classiccontainers.com

A - Total Height.
B - Max. Decorating Area.