

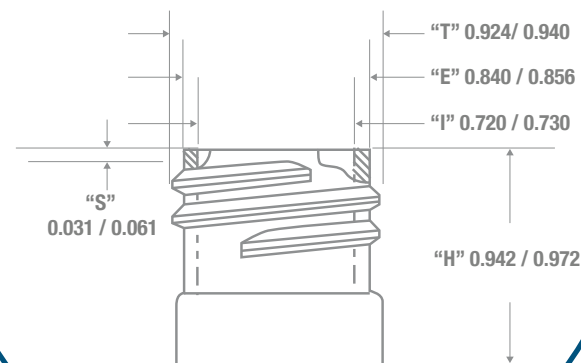

NECK & THREAD DETAIL



FRONT VIEW

SIDE VIEW

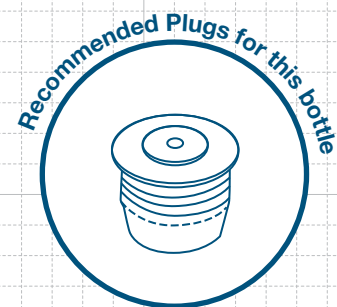
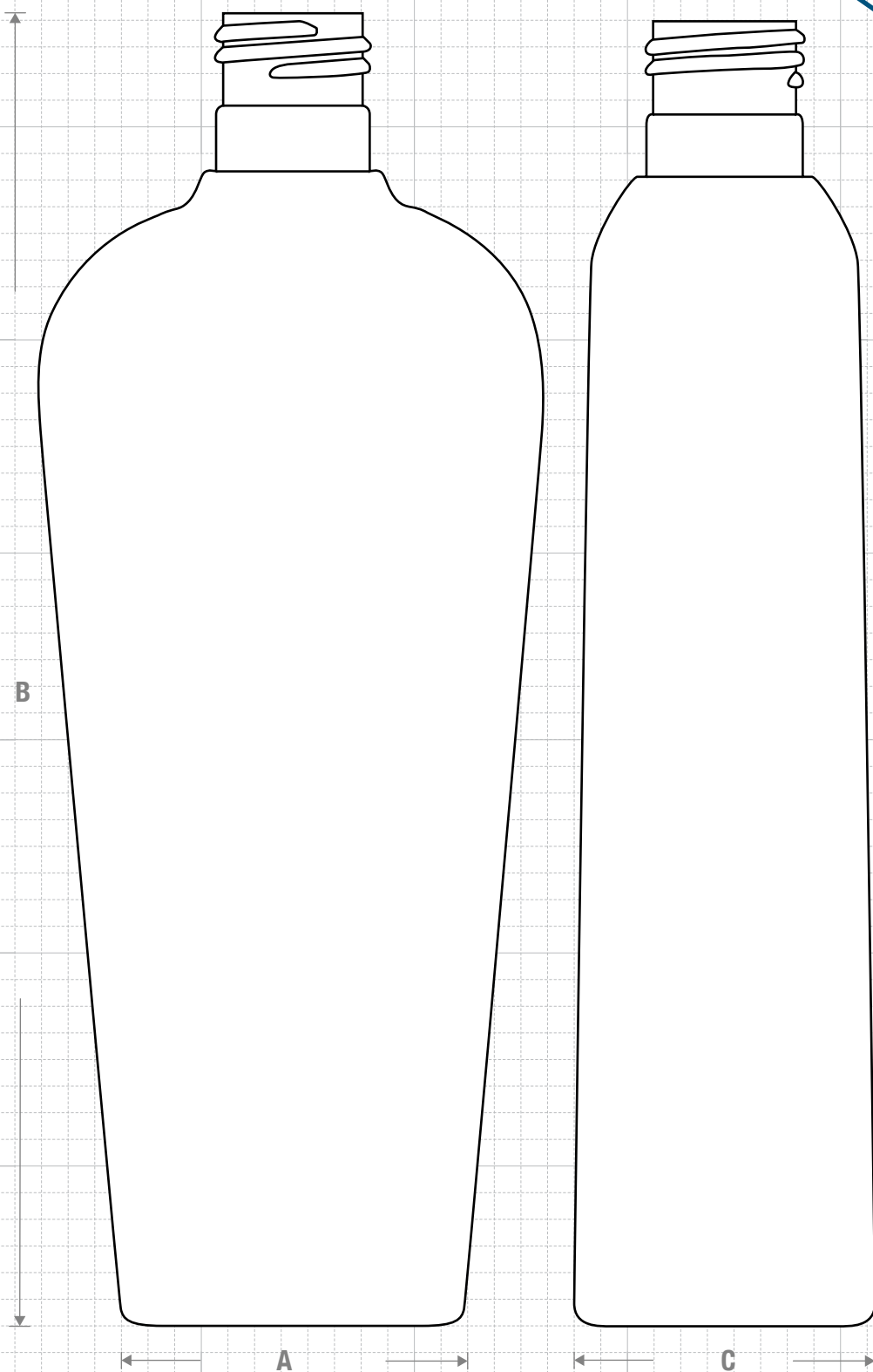

FRICITION FIT

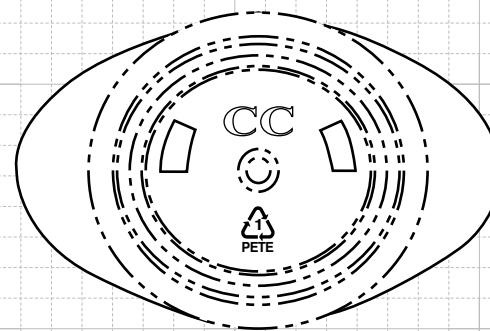

BOTTOM VIEW



CLASSIC CONTAINERS INC
 1700 S. Hellman Ave.
 Ontario, CA 91761
 Phone: 909-930-3610
 e-mail: info@classiccontainers.com
 www.classiccontainers.com

Drawing:
12 oz Vail Oval 24/415

Gram Weight:
31 ± 1

Max Print Area (Height):
5.100"

Cases Per Pallet: **16**

Stock Code:
001200100251700

Neck Finish:
24/415

Max Print Area (Width):
 Shoulder: **1.800"** Base: **1.125"**

Box Dimensions:
24 7/16 x 18 1/2 x 23

Manufacturing Process:
Stretch Blow Molding

Base Width (A) Base Deep (C):
2.100± 0.050 1.900± 0.050

Case Pack: **270**

Stock Material:



Overflow Capacity:
369 - 386 ml (12.5 - 13.1 oz)

Overall Height (B):
7.854 ± 0.050

Case Weight (lb): **21.4 ± 0.6**

Rev #2 01/2016

Drawing not exactly to size.

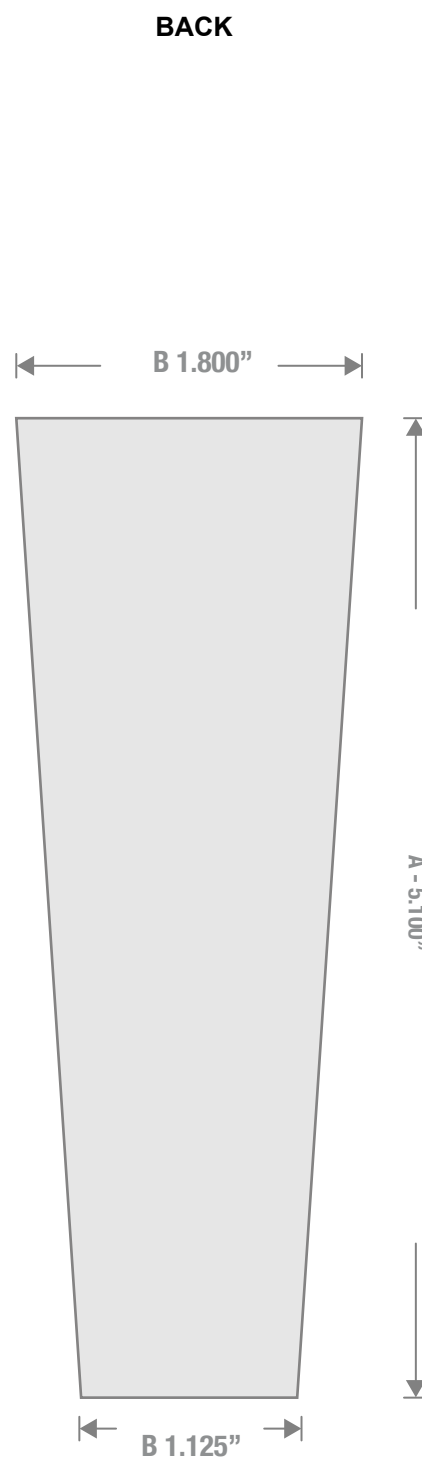
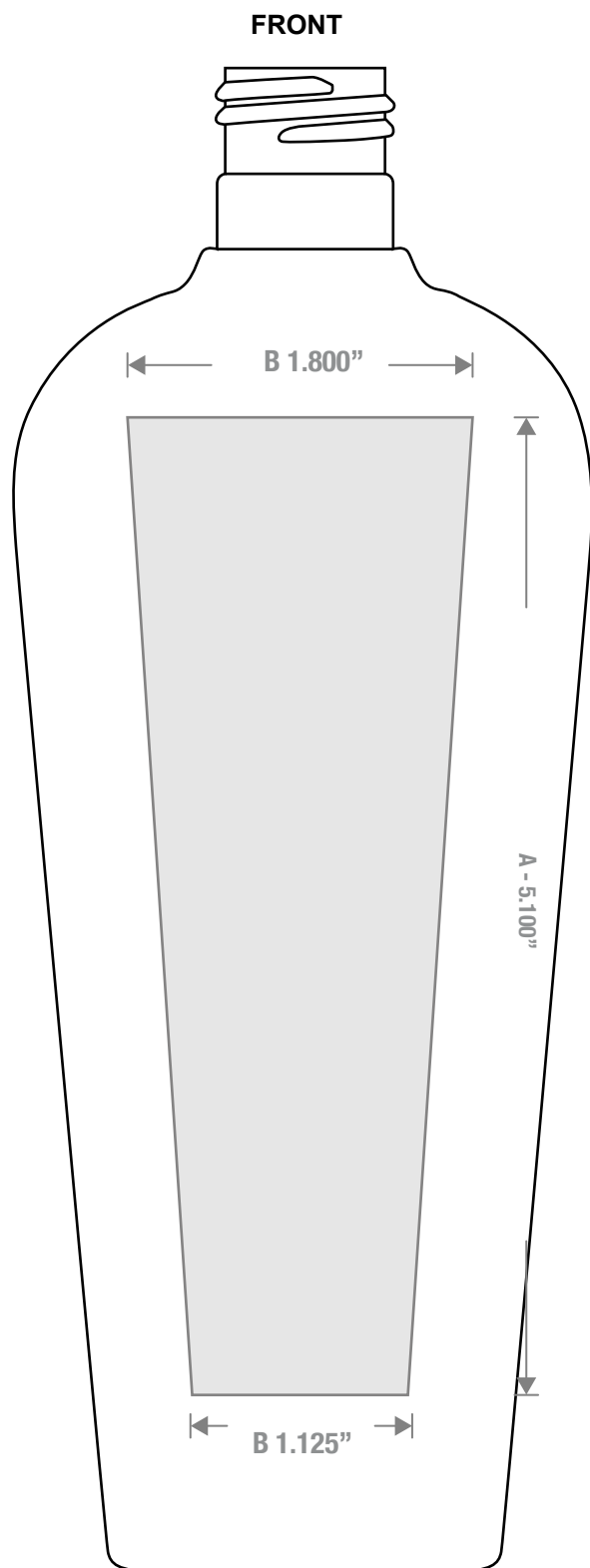

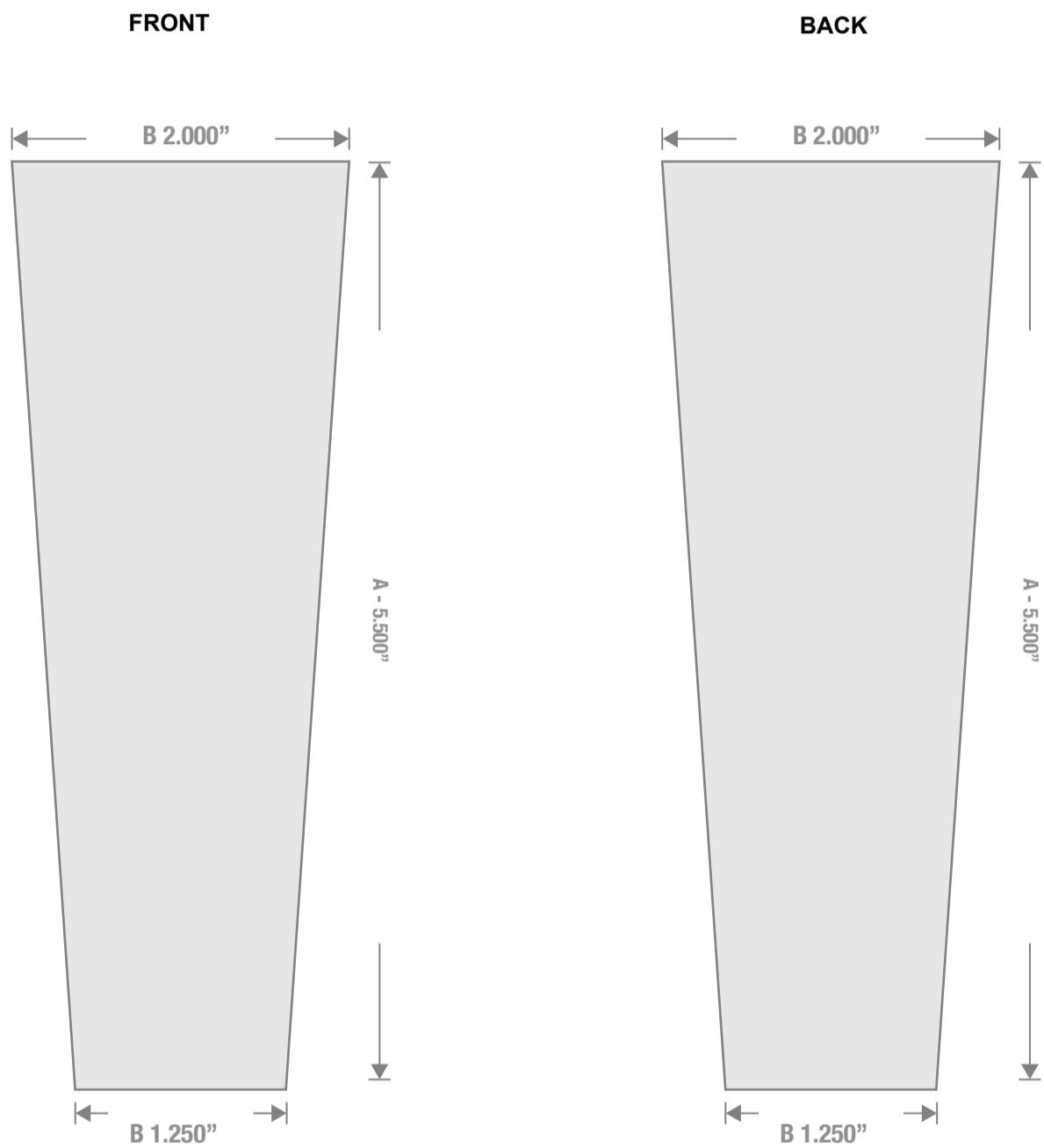

1700 S Hellman Ave, Ontario, California 91761
Phone: (909) 930-3610 | Fax: (909) 930-3640
e-mail: info@classiccontainers.com
www.classiccontainers.com

A - Total Height.
B - Max. Decorating Area.