

NECK & THREAD DETAIL

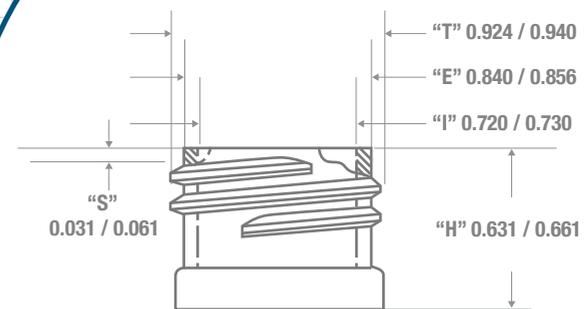

FRONT VIEW

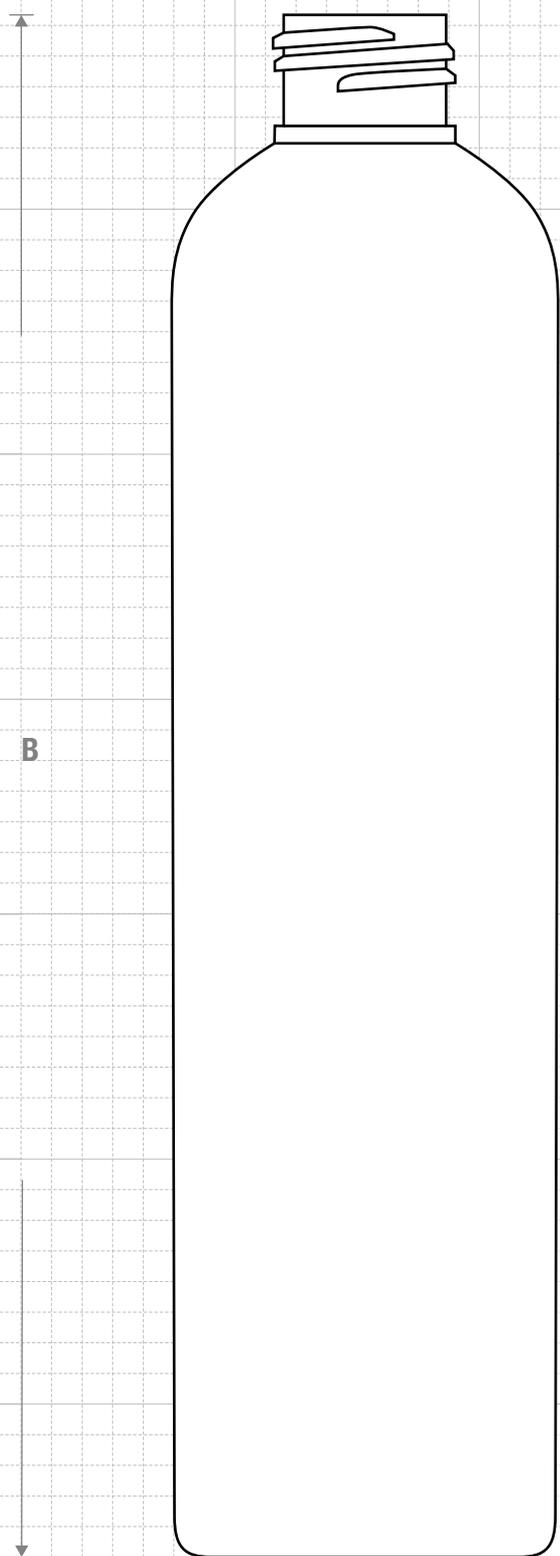

Recommended Plugs for this bottle



FRICTION FIT

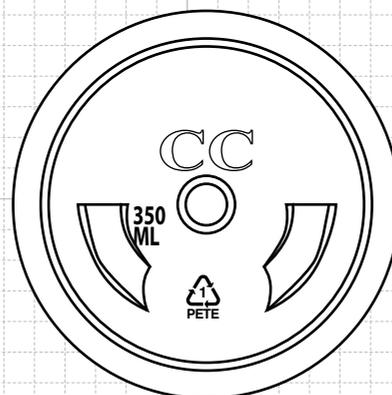

BOTTOM VIEW



CLASSIC CONTAINERS INC
 1700 S. Hellman Ave.
 Ontario, CA 91761
 Phone: 909-930-3610
 e-mail: info@classiccontainers.com
 www.classiccontainers.com

Drawing: 12 oz Imperial Round 24/410	Gram Weight: 31 ± 1	Max Print Area (Height): 5.900"	Cases Per Pallet: 16
Stock Code: 001200050241700	Neck Finish: 24/410	Max Print Area (Width): 6.286"	Box Dimensions: 24 7/16 x 18 1/2 x 23
Manufacturing Process: Stretch Blow Molding	Base Width (A): 2.065 ± 0.050	Case Pack: 295	Stock Material:
Overflow Capacity: 357- 375 ml (12.1 - 12.7 oz)	Overall Height (B): 8.000 ± 0.050	Case Weight (lb): 23.0 ± 0.65	Rev #2 01/2016 Drawing not exactly to size.