

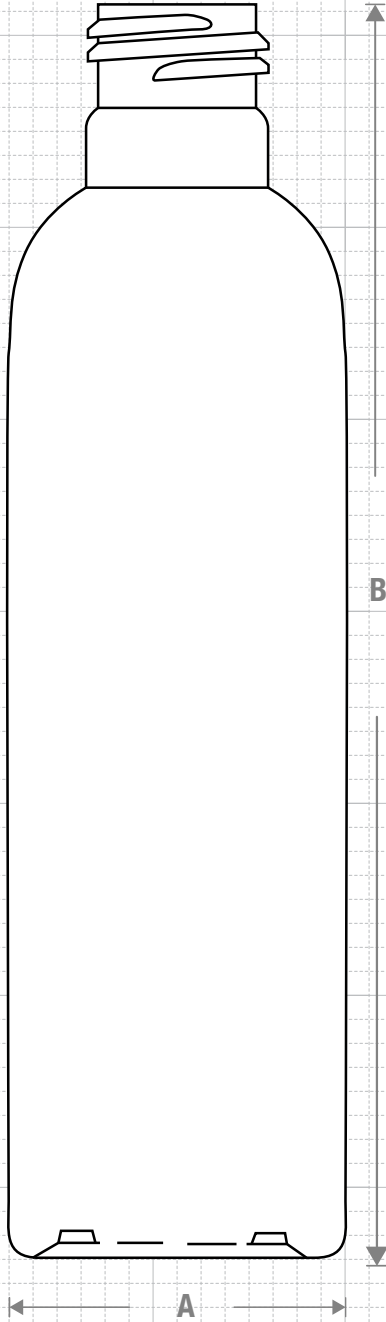

FRONT VIEW



Drawing:
6 oz Imperial Round
24/415

Stock Code:
000600050250000

Manufacturing Process:
Extrusion Blow Molding

Overflow Capacity:
201.0-212 ml (6.8- 7.2 oz)

Gram Weight:
17.0 ± 2

Neck Finish:
24/415

Base Width (A):
1.770 ± 0.050

Overall Height (B):
6.600± 0.050

Max Print Area (Height):
4500"

Max Print Area (Width):
5.312"

Case Pack: 546

Case Weight (lb): 23.4± 2.4

Cases Per Pallet: 16

Box Dimensions:
24 7/16 x18 1/2 x23

Stock Material:

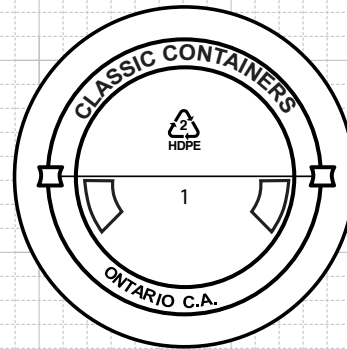
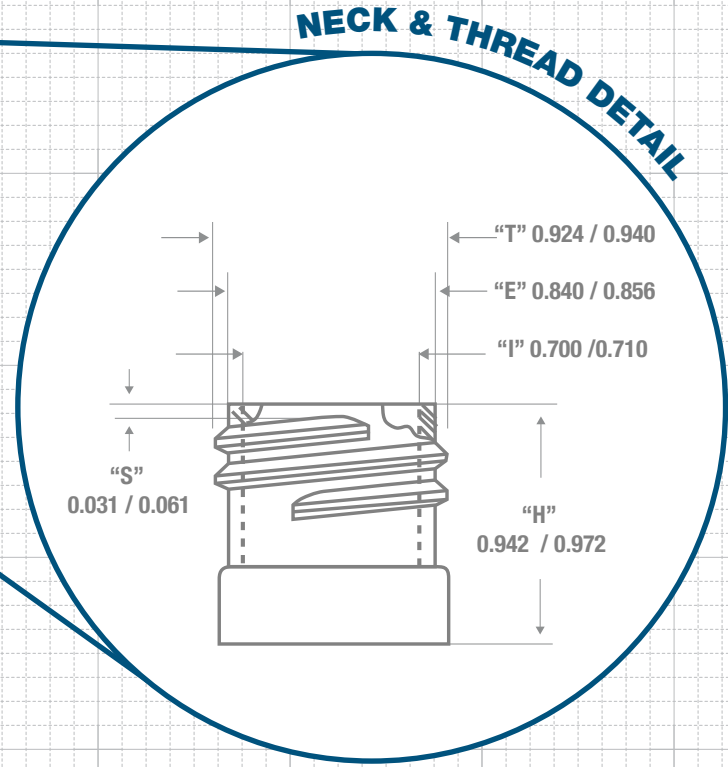
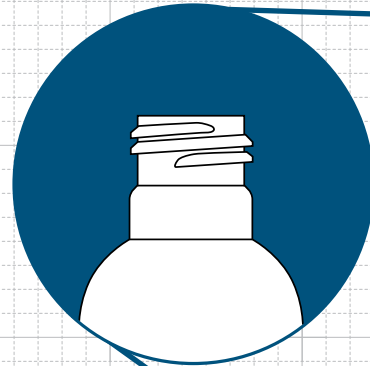

BOTTOM VIEW

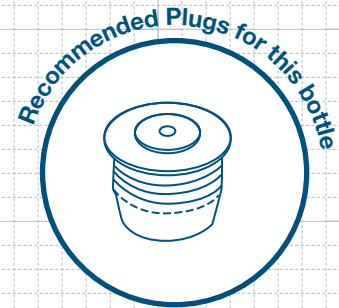

FRICION FIT

CLASSIC CONTAINERS INC

1700 S. Hellman Ave.
Ontario, CA 91761
Phone: 909-930-3610
e-mail: info@classiccontainers.com
www.classiccontainers.com

LABELING AREA

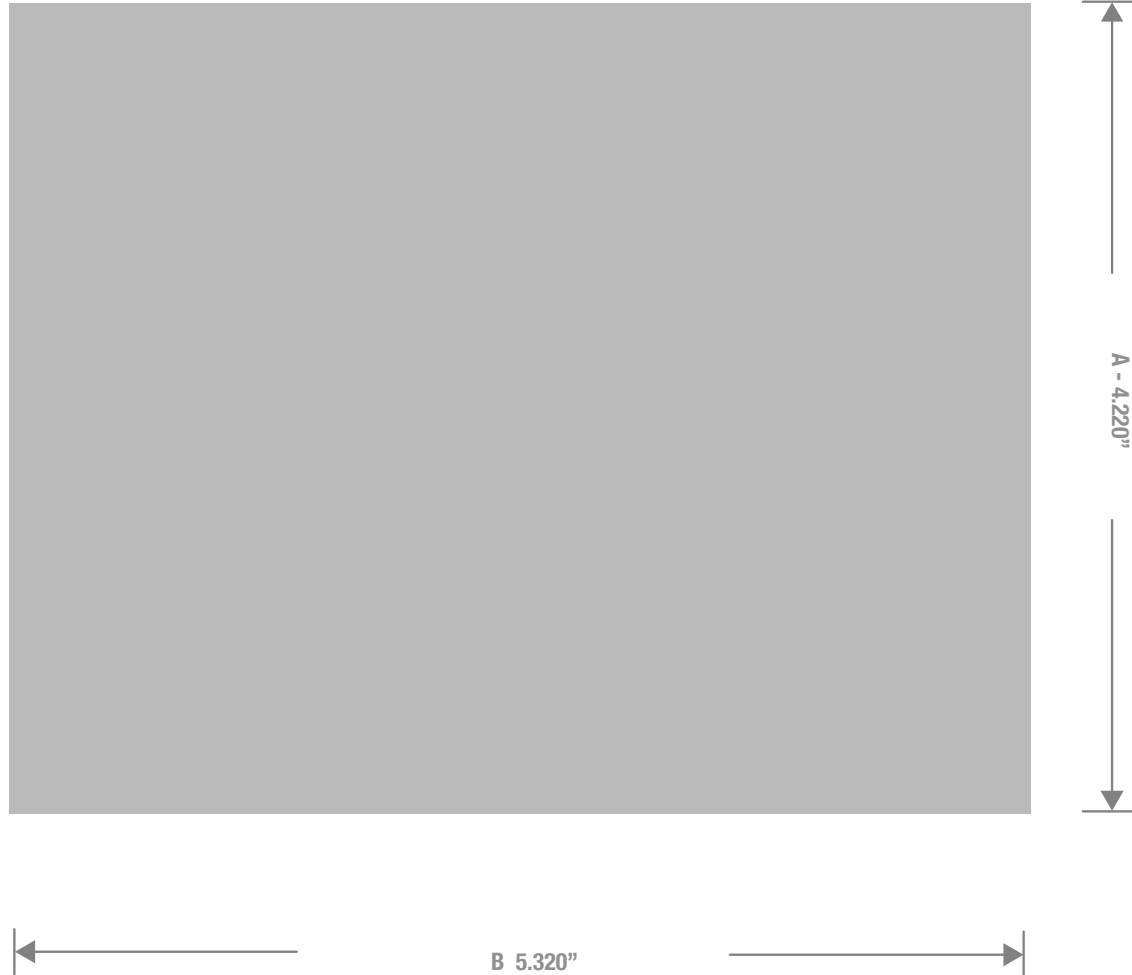

1700 S Hellman Ave, Ontario, California 91761
Phone: (909) 930-3610 | Fax: (909) 930-3640
e-mail: info@classiccontainers.com
www.classiccontainers.com

A - Total Height.
B - Total Width

PRINTING SPECIFICATIONS: 6 oz IMPERIAL ROUND 24/415

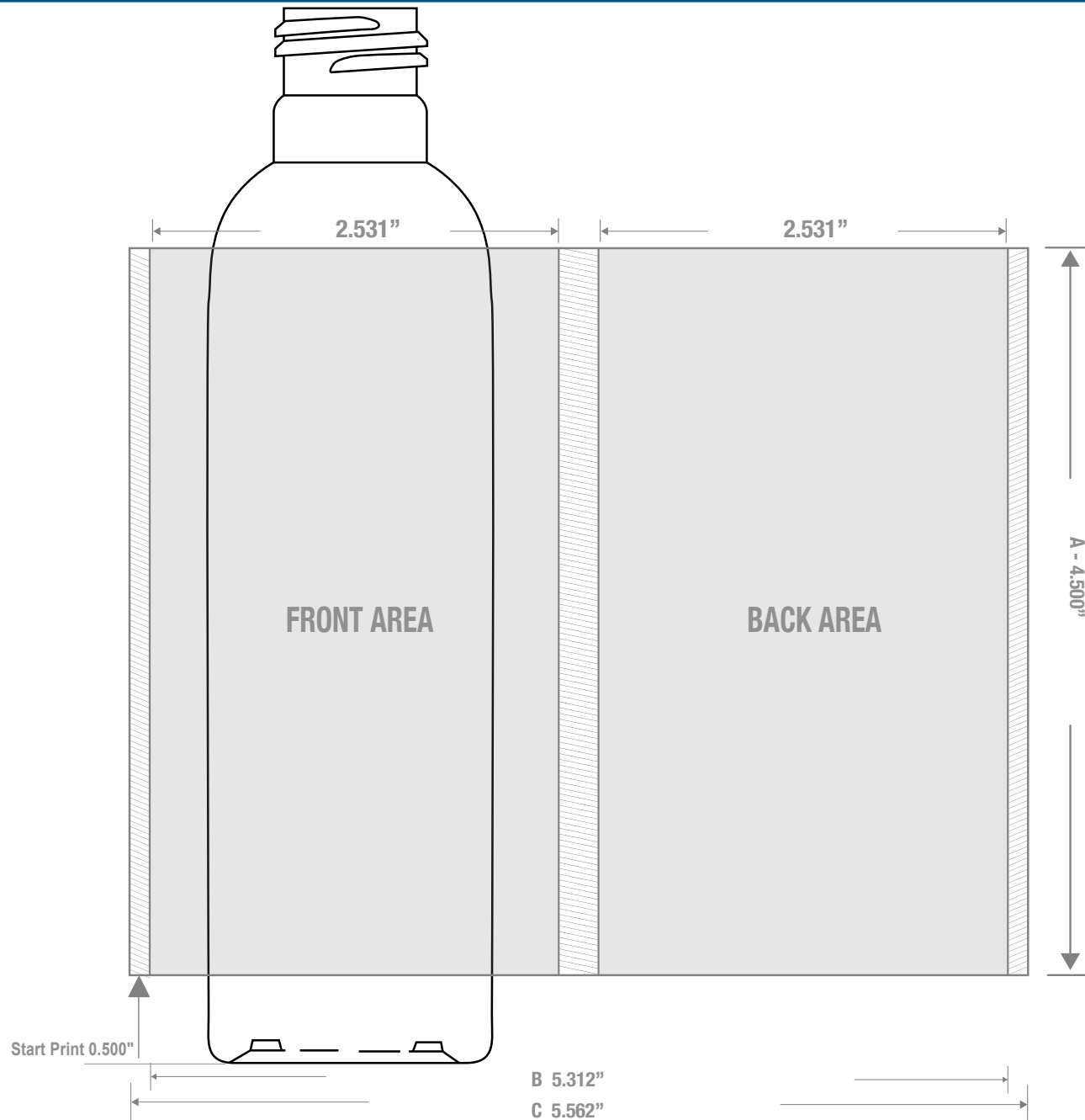

1700 S Hellman Ave, Ontario, California 91761
Phone: (909) 930-3610 | Fax: (909) 930-3640
e-mail: info@classiccontainers.com
www.classiccontainers.com

A - Total Height.
B - Max. Decorating Area.
C - Total bottle circumference.
▨ - Unprintable area.