



Drawing:
4 oz Imperial Round 20/410

Stock Code:
000400050217000

Manufacturing Process:
Stretch Blow Molding

Overflow Capacity:
124 - 136ml (4.2 - 4.6 oz)

Gram Weight:
15 ± 1

Neck Finish:
20/410

Base Width (A):
1.537 ± 0.050

Overall Height (B):
5.296 ± 0.050

Max Print Area (Height):
3.750"

Max Print Area (Width):
4.500"

Case Pack: 480

Case Weight (lb): 18.0 ± 1.0

Cases Per Pallet: 25

Box Dimensions:
23 5/8 x 15 9/16 x 17

Stock Material:



FRONT VIEW

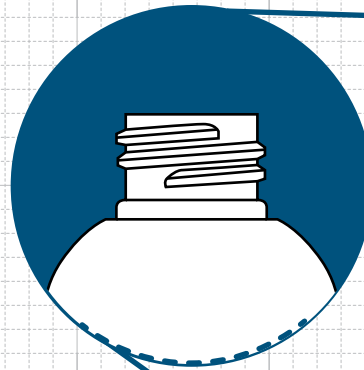
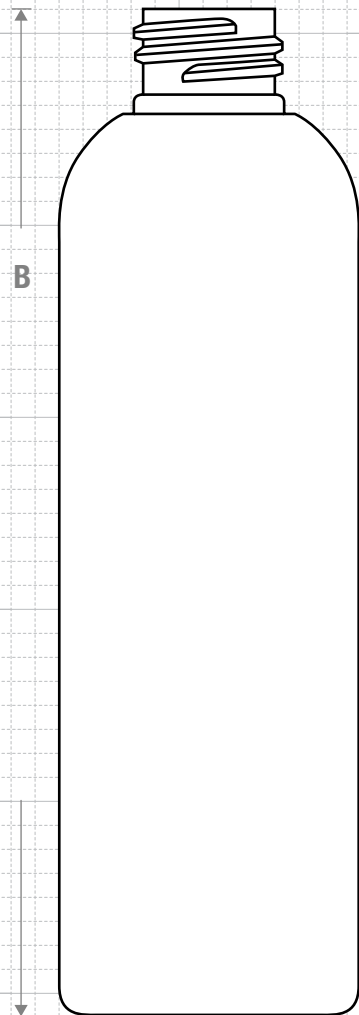

NECK & THREAD DETAIL

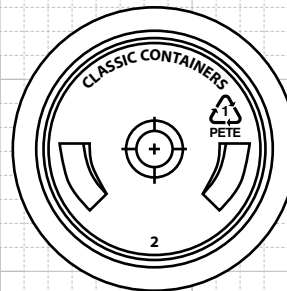
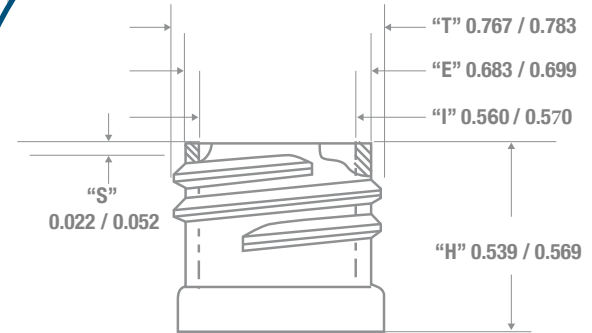

BOTTOM VIEW

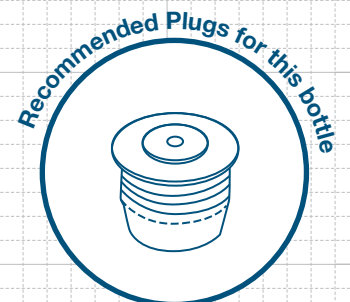
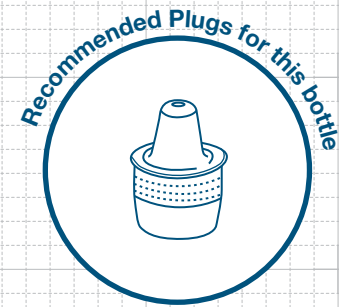

FRICION FIT

CLASSIC CONTAINERS INC
1700 S. Hellman Ave.
Ontario, CA 91761
Phone: 909-930-3610
e-mail: info@classiccontainers.com
www.classiccontainers.com

PRINTING SPECIFICATIONS: 4 oz IMPERIAL ROUND 20/410 PETE

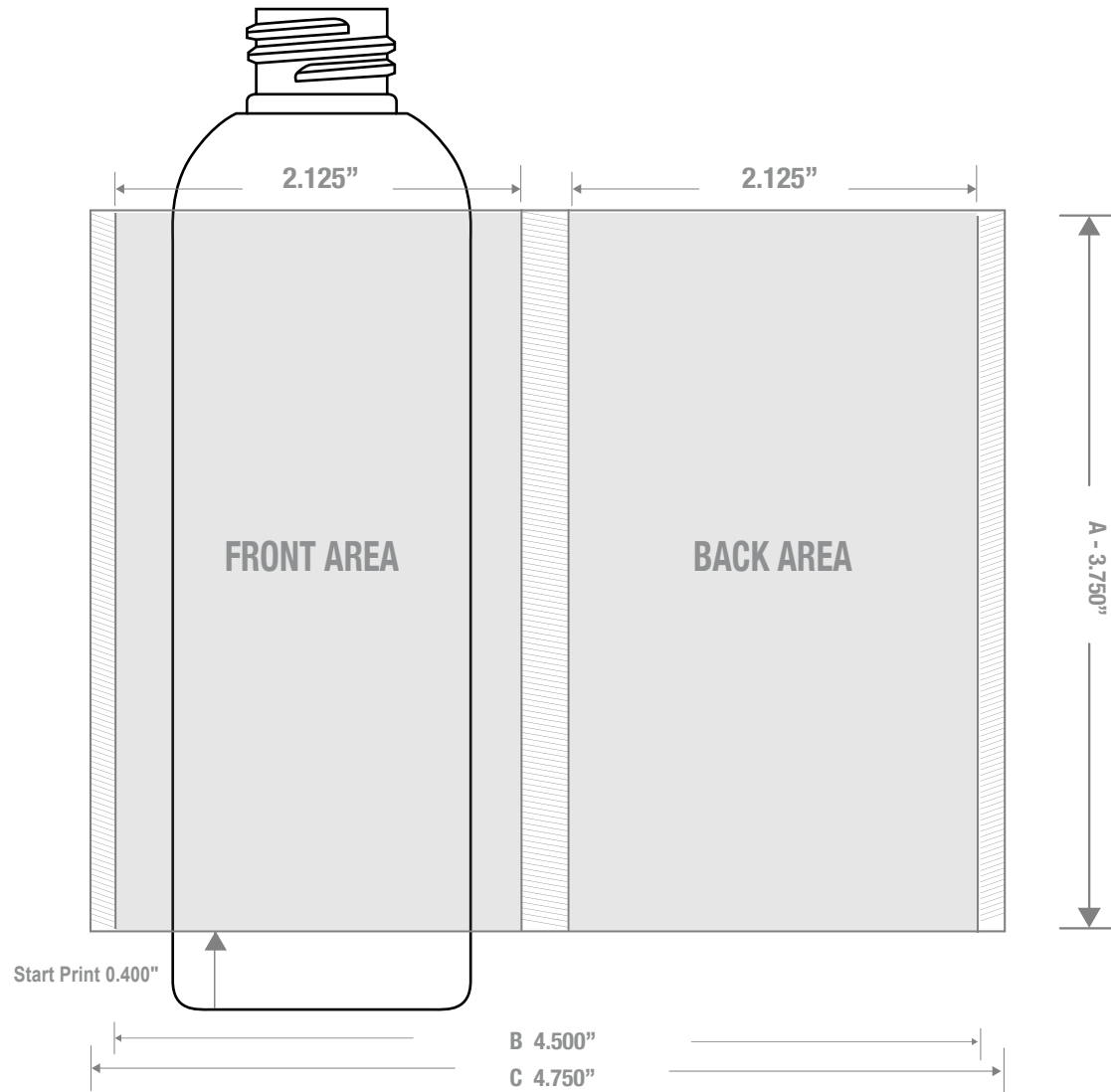

1700 S Hellman Ave, Ontario, California 91761
Phone: (909) 930-3610 | Fax: (909) 930-3640
e-mail: info@classiccontainers.com
www.classiccontainers.com

A - Total Height.
B - Max. Decorating Area.
C - Total bottle circumference.
☒ - Unprintable area.

LABELING SPECIFICATIONS: 4 oz IMPERIAL ROUND 20/410 PETE



1700 S Hellman Ave, Ontario, California 91761
Phone: (909) 930-3610 | Fax: (909) 930-3640
e-mail: info@classiccontainers.com
www.classiccontainers.com

A - Total Height.
B - Max. Decorating Area.
C - Total bottle circumference.
☒ - Unprintable area.