

### NECK & THREAD DETAIL

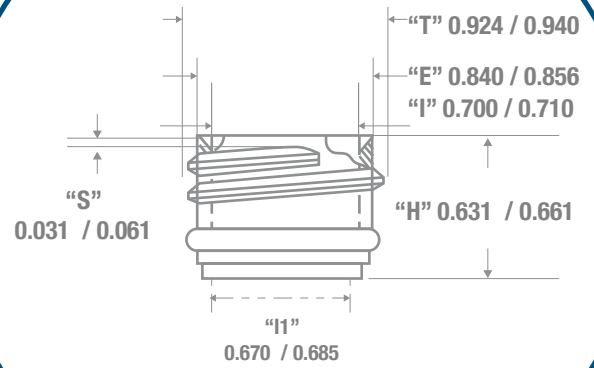

### FRONT VIEW

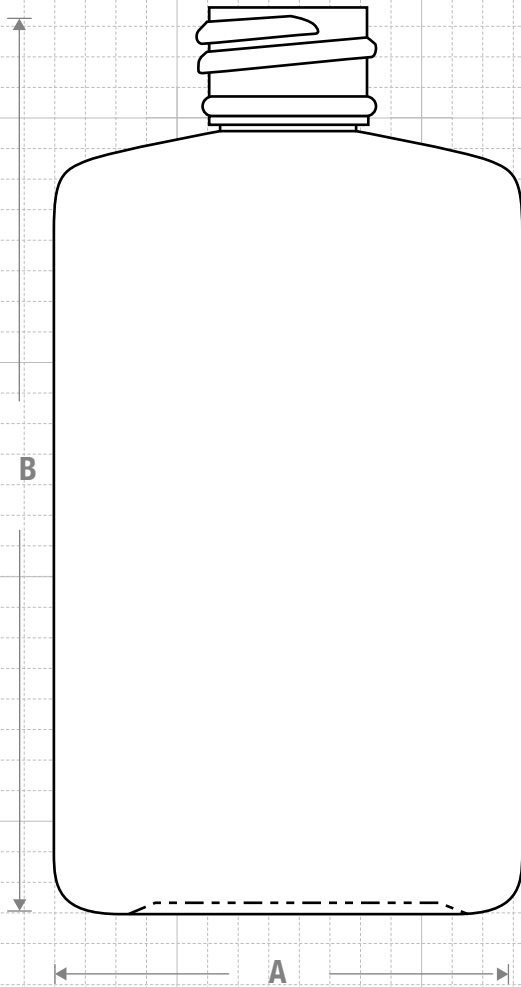

### SIDE VIEW

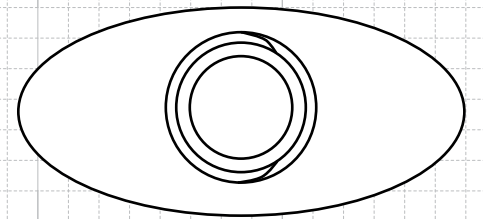
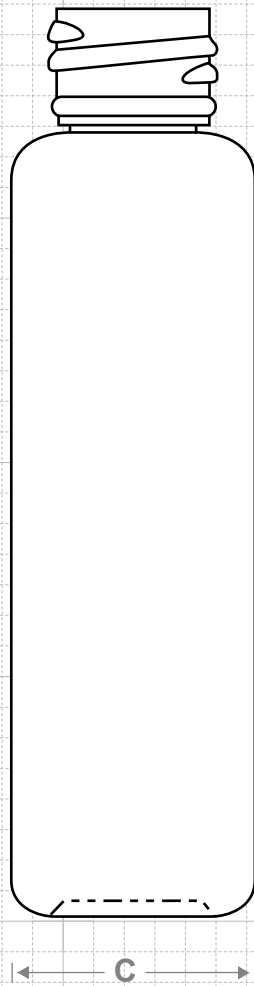

### TOP VIEW

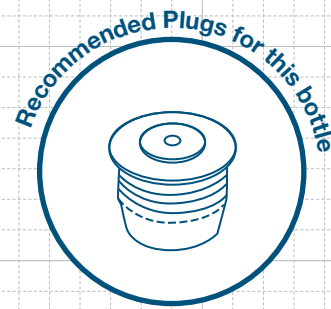

### FRICION FIT

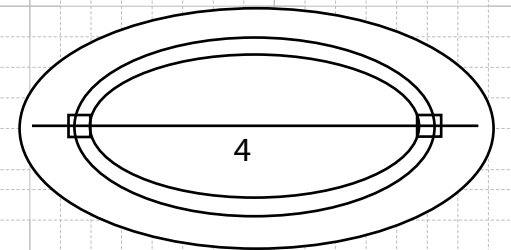

### BOTTOM VIEW



**CLASSIC CONTAINERS INC**  
 1700 S. Hellman Ave.  
 Ontario, CA 91761  
 Phone: 909-930-3610  
 e-mail: info@classiccontainers.com  
 www.classiccontainers.com

Drawing:  
**4 oz Drug Oval 24/410**

Gram Weight:  
**14 ± 2**

Max Print Area (Height):  
**3.000"**

Cases Per Pallet: **25**

Stock Code:  
**000400210240000**

Neck Finish:  
**24/410**

Max Print Area (Width):  
**1.750"**

Box Dimensions:  
**23<sup>5/8</sup> x 15<sup>9/16</sup> x 17**

Manufacturing Process:  
**Extrusion Blow Molding**

Base Width (A): Base Deep (C)  
**2.468 ± 0.050 1.252 ± 0.050**

Case Pack: **495**

Stock Material:



Overflow Capacity:  
**127 - 139 ml (4.3 - 4.7 oz)**

Overall Height (B):  
**4.709 ± 0.050**

Case Weight (lb): **17.4 ± 2.2**

Rev #3 - 01/2019 Drawing not exactly to size.

**FRONT**

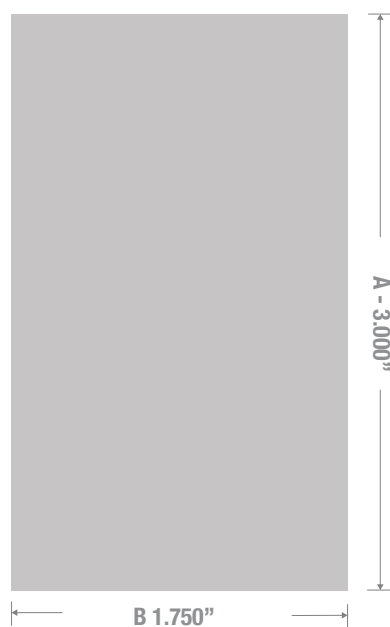

**BACK**

