

NECK & THREAD DETAIL

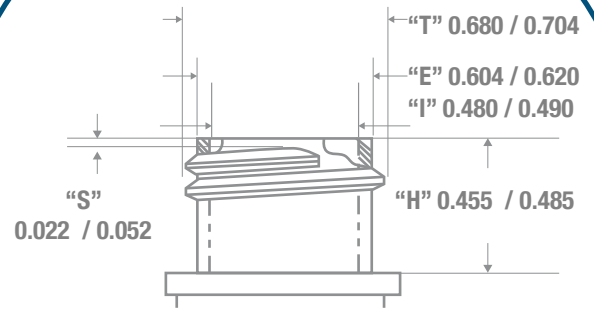

FRONT VIEW

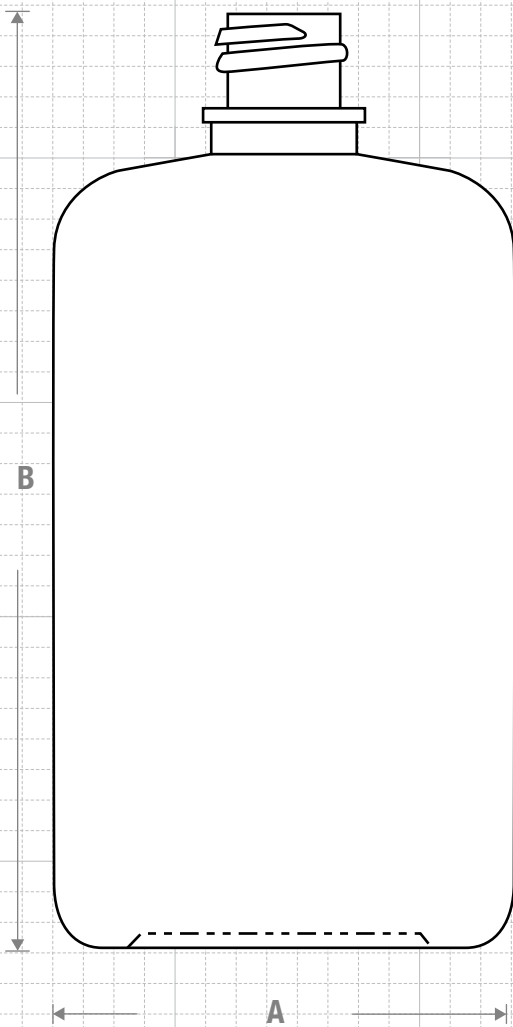

SIDE VIEW

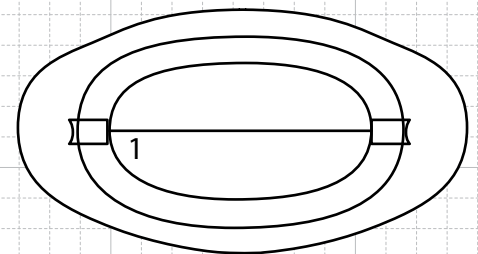
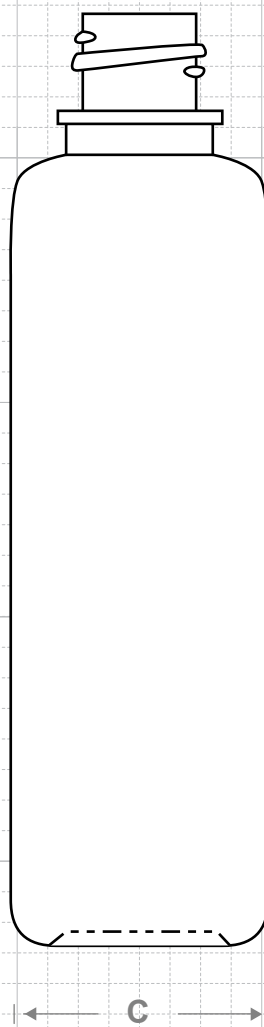

BOTTOM VIEW

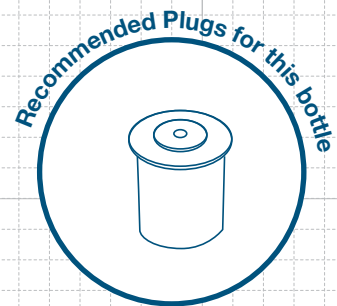

Recommended Plugs for this bottle

FRICION FIT

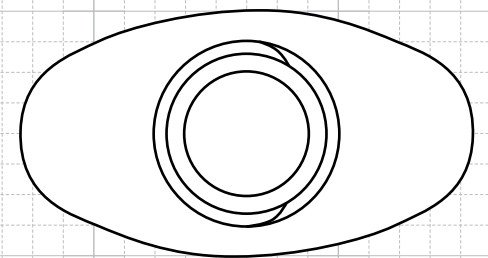

TOP VIEW



CLASSIC CONTAINERS INC
1700 S. Hellman Ave.
Ontario, CA 91761
Phone: 909-930-3610
e-mail: info@classiccontainers.com
www.classiccontainers.com

Drawing:
4 oz Drug Oval 18/410
W/R M-2

Stock Code:
00040002118R00M2

Manufacturing Process:
Extrusion Blow Molding

Overflow Capacity:
136 - 148 ml (4.6 - 5.0 oz)

Gram Weight:
14 ± 2

Neck Finish:
18/410 W/R

Base Width (A): Base Deep (C)
2.385 ± 0.050 1.310 ± 0.050

Overall Height (B):
4.850 ± 0.050

Max Print Area (Height):
3.000"

Max Print Area (Width):
1.750"

Case Pack: **432**

Case Weight (lb): **15.5 ± 1.9**

Cases Per Pallet: **25**

Box Dimensions:
23 5/8 x 15 9/16 x 17

Stock Material:



Rev #4 - 10/2015

Drawing not exactly to size.

FRONT

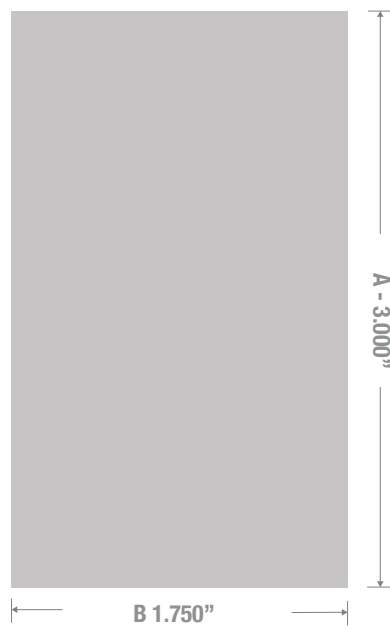

BACK

