



Drawing:
4 oz Classic Oval 24/415

Stock Code:
000400230250000

Manufacturing Process:
Extrusion Blow Molding

Overflow Capacity:
124 - 136 ml (4.2 - 4.6 oz)

Gram Weight:
13.5 ± 1

Neck Finish:
24/415

Base Width (A): Base Depth (C)
1.960 ± 0.050 1.195 ± 0.050

Overall Height (B):
5.410 ± 0.005

Max Print Area (Height):
3.500"

Max Print Area (Width):
1.313"

Case Pack: 497

Case Weight (lb): 16.9 ± 1.1

Cases Per Pallet: 25

Box Dimensions:
23 5/8 x 15 9/16 x 17

Stock Material:



CLASSIC CONTAINERS INC
1700 S. Hellman Ave.
Ontario, CA 91761
Phone: 909-930-3610
e-mail: info@classiccontainers.com
www.classiccontainers.com

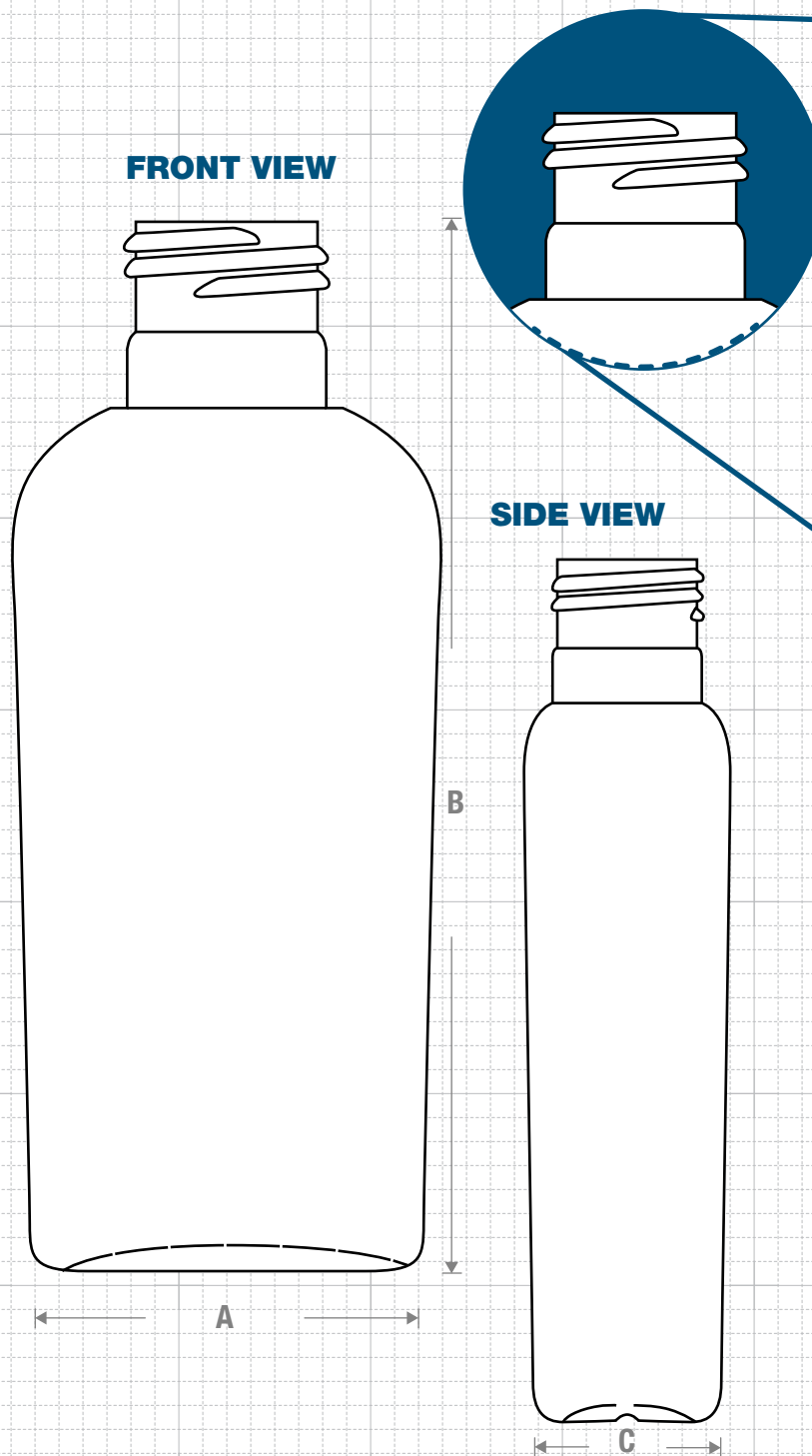

FRONT VIEW

SIDE VIEW

B

A

C

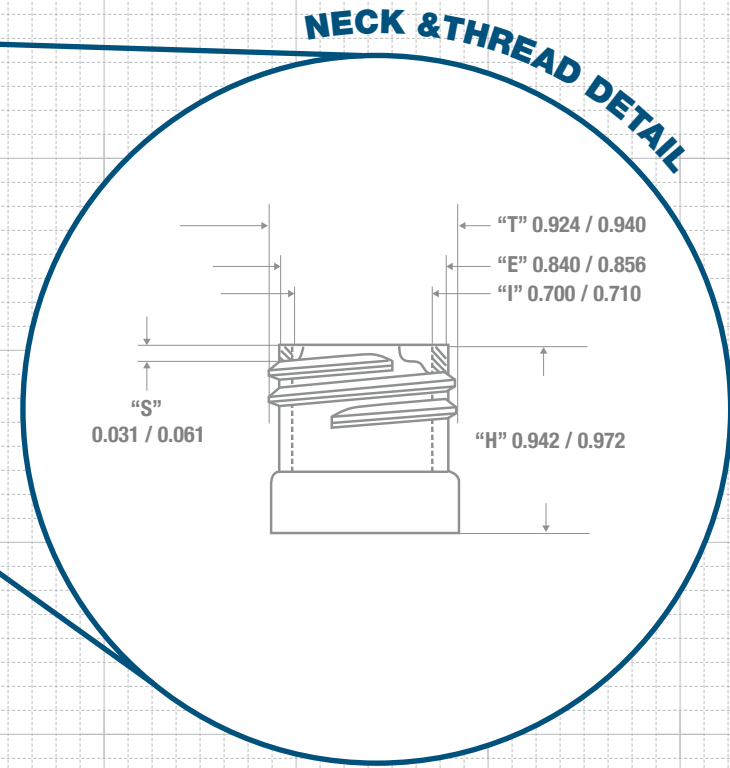
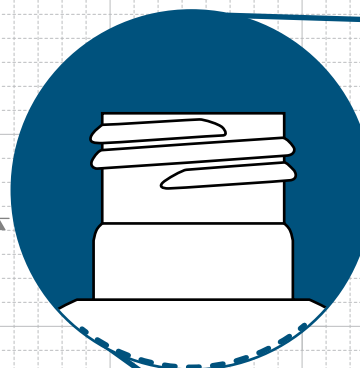

NECK & THREAD DETAIL

"T" 0.924 / 0.940
"E" 0.840 / 0.856
"I" 0.700 / 0.710
"S" 0.031 / 0.061
"H" 0.942 / 0.972

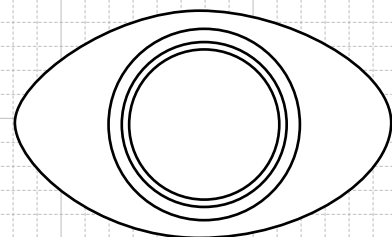

TOP VIEW

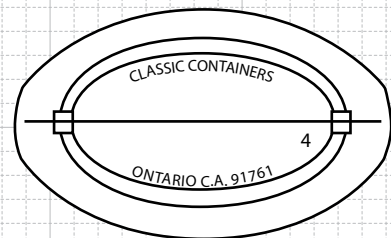

BOTTOM VIEW

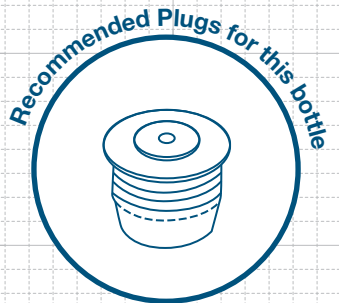

FRICITION FIT



PRINTING SPECIFICATIONS: 4 oz CLASSIC OVAL 24/415

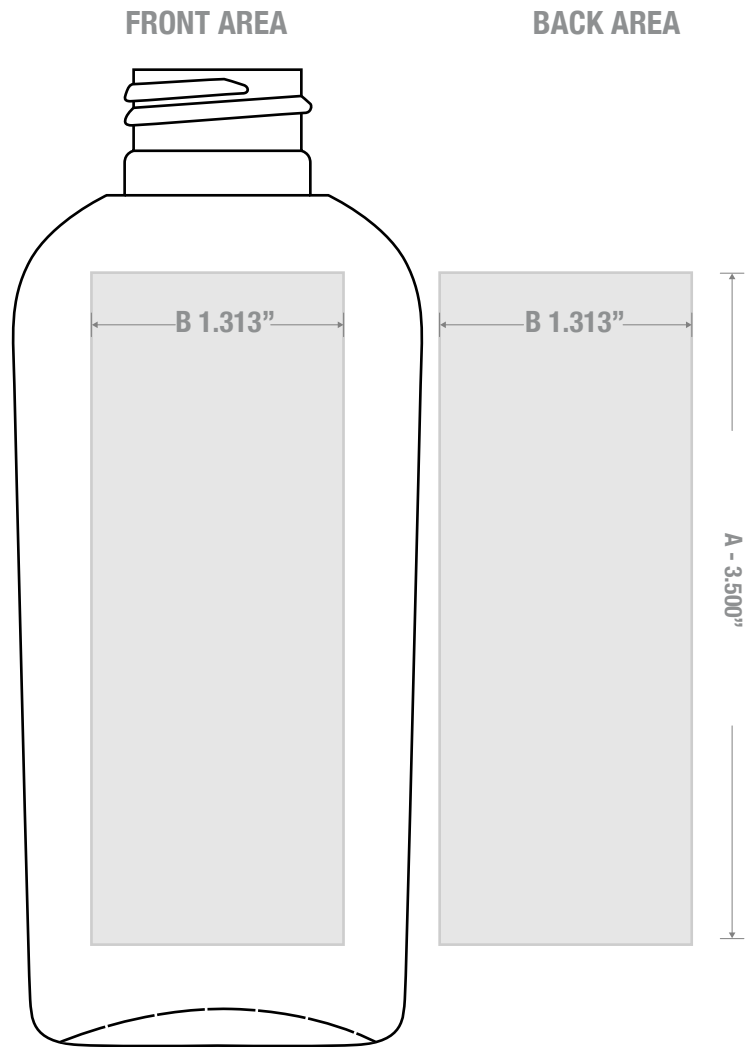

1700 S Hellman Ave, Ontario, California 91761
Phone: (909) 930-3610 | Fax: (909) 930-3640
e-mail: info@classiccontainers.com
www.classiccontainers.com

A - Total Height.
B - Max. Decorating Area.

LABELING SPECIFICATIONS: 4 oz CLASSIC OVAL 24/415

FRONT AREA

BACK AREA

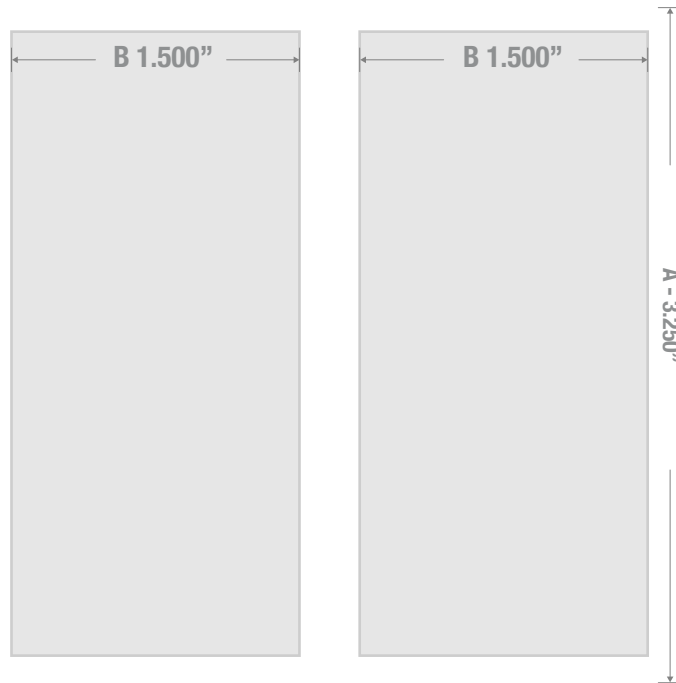

1700 S Hellman Ave, Ontario, California 91761
Phone: (909) 930-3610 | Fax: (909) 930-3640
e-mail: info@classiccontainers.com
www.classiccontainers.com

A - Total Height.
B - Max. Decorating Area.