

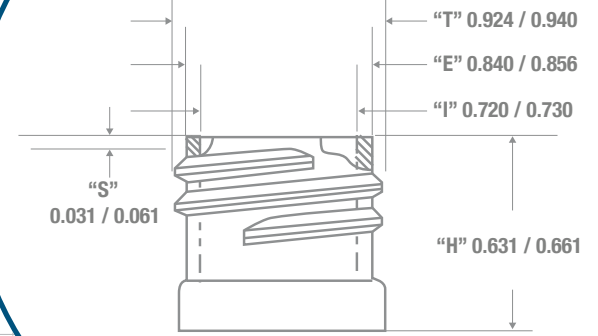

NECK & THREAD DETAIL



FRONT VIEW

SIDE VIEW

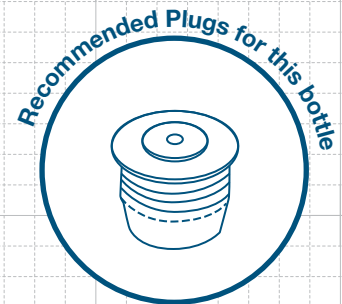
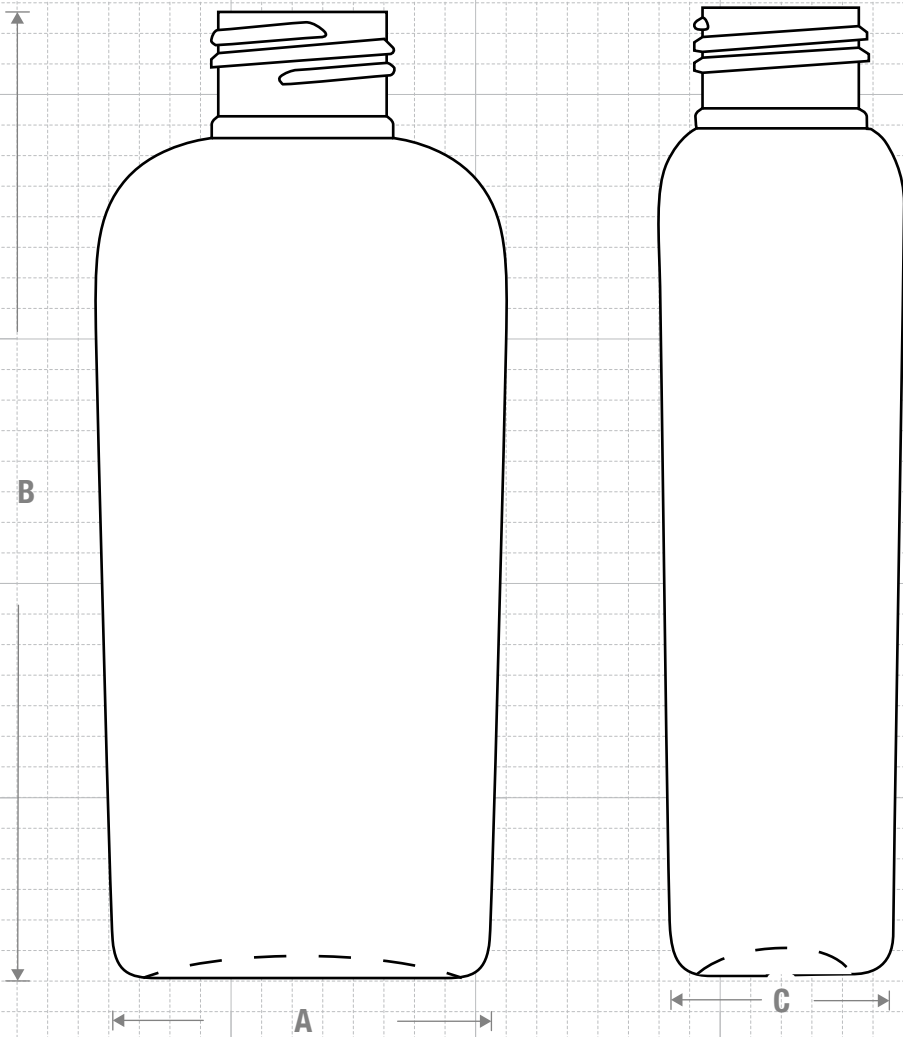

FRICITION FIT

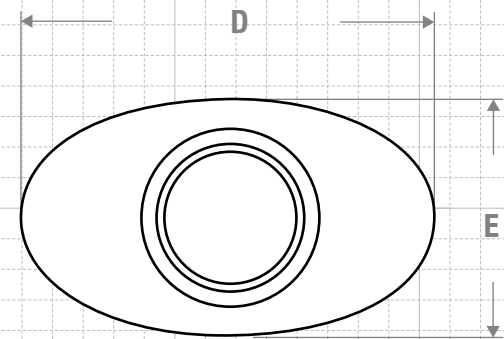

TOP VIEW

D Shoulder Width: 2.157 ± 0.050
 E Shoulder Depth: 1.285 ± 0.050

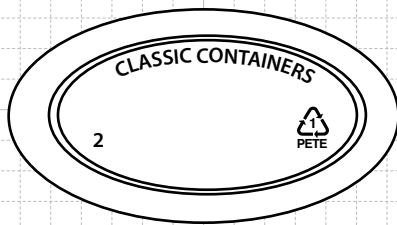

BOTTOM VIEW



CLASSIC CONTAINERS INC
 1700 S. Hellman Ave.
 Ontario, CA 91761
 Phone: 909-930-3610
 e-mail: info@classiccontainers.com
 www.classiccontainers.com

Drawing:
4 oz Classic Oval 24/410

Gram Weight:
15 ± 1

Max Print Area (Height):
3.400"

Cases Per Pallet: **25**

Stock Code:
000400230241700

Neck Finish:
24/410

Max Print Area (Width):
1.300"

Box Dimensions:
23 5/8 x 15 9/16 x 17

Manufacturing Process:
Stretch Blow Molding

Base Width (A) Base Deep (C):
2.033± 0.050 1.124± 0.050

Case Pack: **474**

Stock Material:



Overflow Capacity:
129 - 142 ml (4.4- 4.8 oz)

Overall Height (B):
5.047 ± 0.050

Case Weight (lb): **17.8 ± 1.0**

Rev #2 02/2016

Drawing not exactly to size.

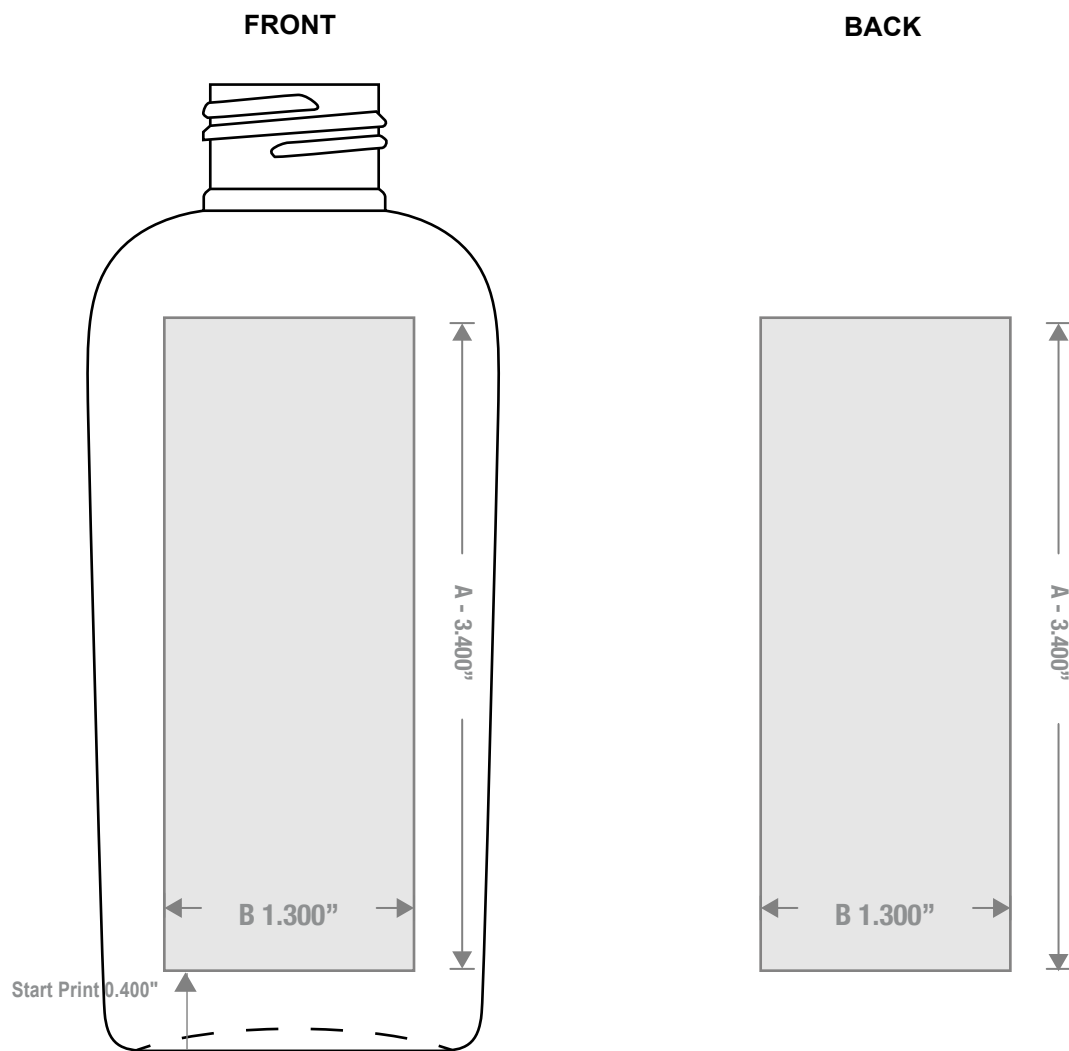

FRONT



BACK

