



Drawing:
300 ml Boston Round 24/415

Stock Code:
030000060251700

Manufacturing Process:
Stretch Blow Molding

Overflow Capacity:
316 - 333 ml (10.7 - 11.3 oz)

Gram Weight:
25 ± 1

Neck Finish:
24/415

Base Width (A):
2.465 ± 0.050

Overall Height (B):
5.470 ± 0.050

Max Print Area (Height):
3.250"

Max Print Area (Width):
7.574"

Case Pack: **308**

Case Weight (lb): **19.9 ± 0.7**

Cases Per Pallet: **16**

Box Dimensions:
24 7/16 x 18 1/2 x 23

Stock Material:



CLASSIC CONTAINERS INC
1700 S. Hellman Ave.
Ontario, CA 91761
Phone: 909-930-3610
e-mail: info@classiccontainers.com
www.classiccontainers.com

FRONT VIEW

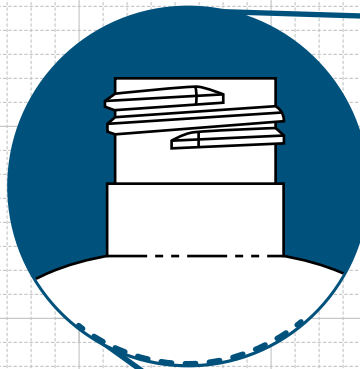
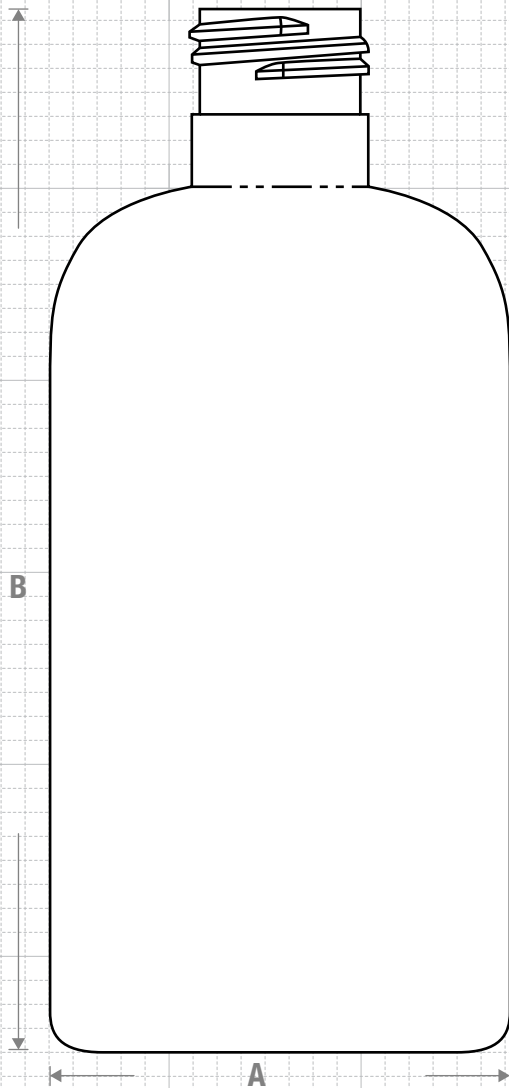

NECK & THREAD DETAIL

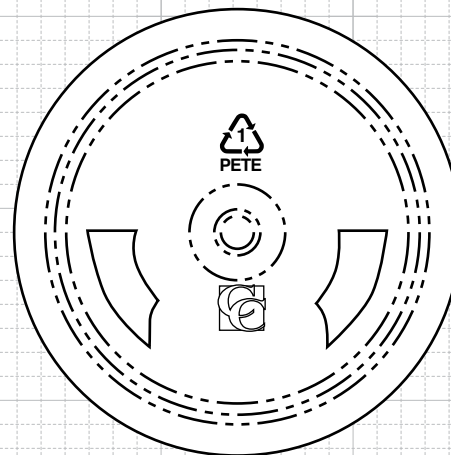
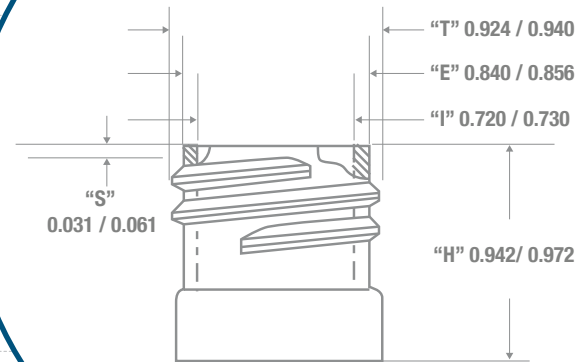

BOTTOM VIEW

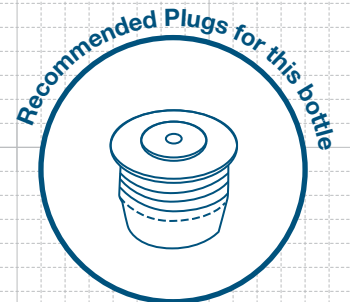

FRICION FIT

PRINTING SPECIFICATIONS: 300 ml BOSTON ROUND 24/415

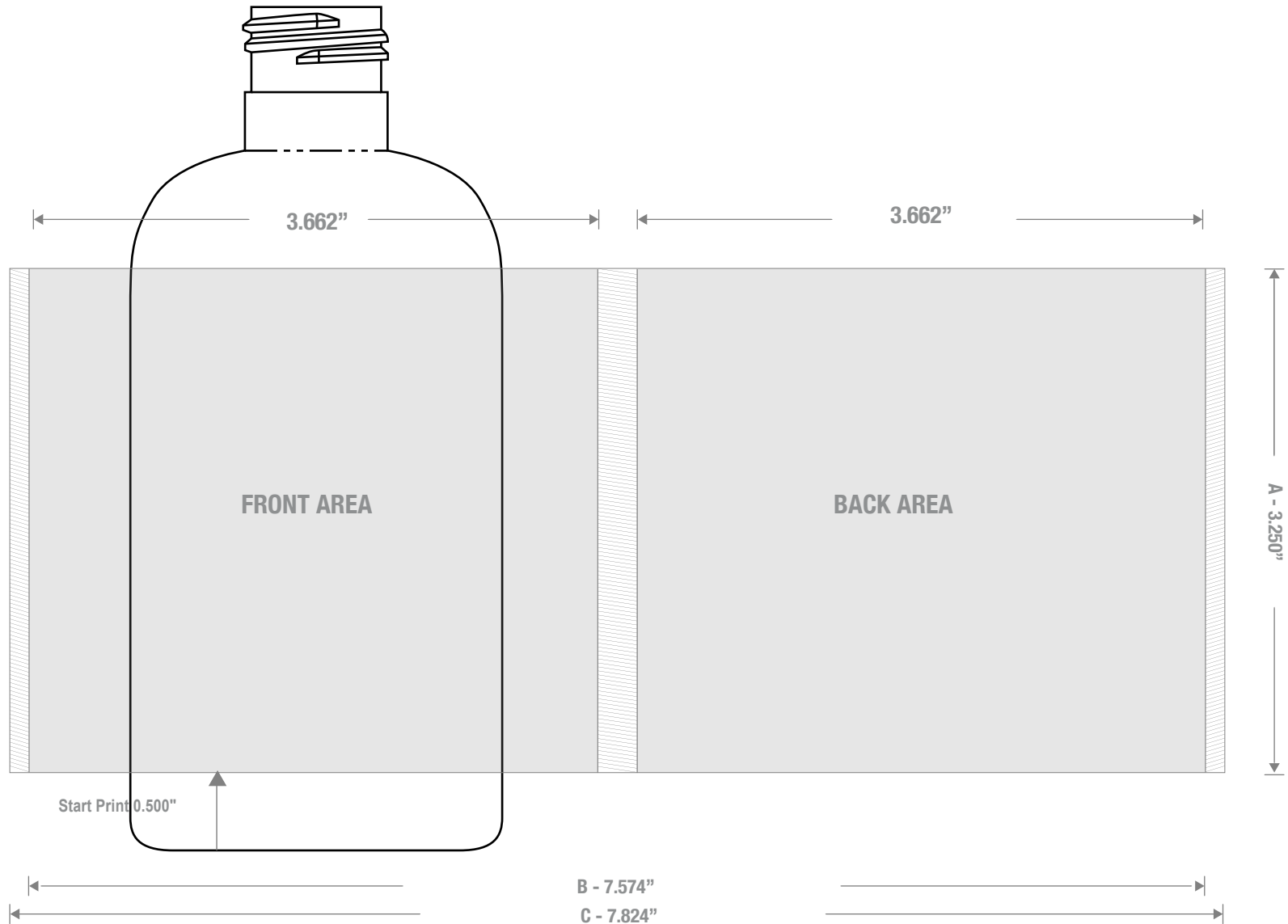

1700 S Hellman Ave, Ontario, California 91761
 Phone: (909) 930-3610 | Fax: (909) 930-3640
 e-mail: info@classiccontainers.com
www.classiccontainers.com

A - Total Height.
B - Max. Decorating Area.
C - Total bottle circumference.
 [Hatched Box] - Unprintable area.

LABELING SPECIFICATIONS: 300 ml BOSTON ROUND 24/415

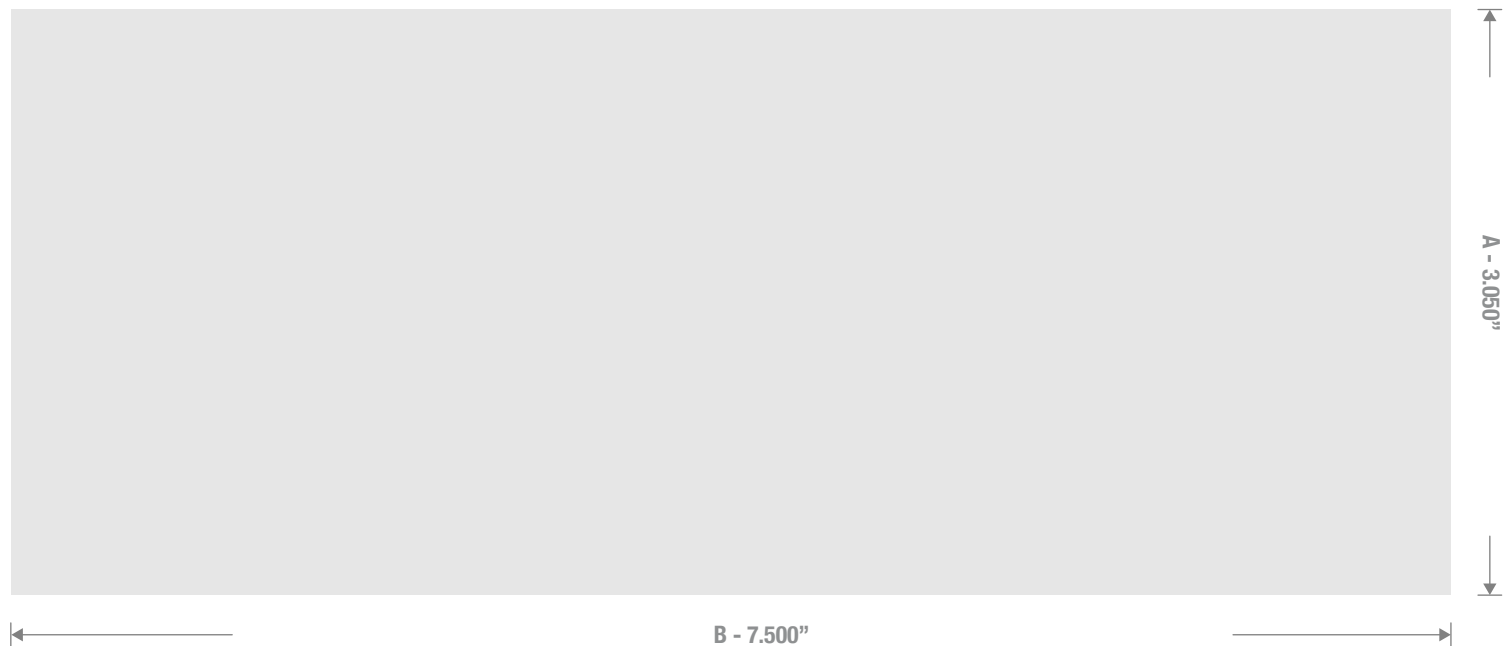

1700 S Hellman Ave, Ontario, California 91761
Phone: (909) 930-3610 | Fax: (909) 930-3640
e-mail: info@classiccontainers.com
www.classiccontainers.com

A - Total Height.
B - Max. Decorating Area.