



Drawing:  
2 oz Vail Oval 20/415

Stock Code:  
000200100210000

Manufacturing Process:  
Extrusion Blow Molding

Overflow Capacity:  
64.9 - 73.8 ml (2.5- 2.5 oz)

Gram Weight:  
9.0 ± 1

Neck Finish:  
20/415

Base Width (A) Base Deep (C):  
1.250 ± 0.050 / 1.150 ± 0.050

Overall Height (B):  
4.223 ± 0.050

Max Print Area (Height):  
2.500"

Max Print Area (Width):  
Shoulder 1.250" Base 0.750

Case Pack: 920

Case Weight (lb): 20.4 ± 2.0

Cases Per Pallet: 25

Box Dimensions:  
23 5/8 x 15 9/16 x 17

Stock Material:



### FRONT VIEW

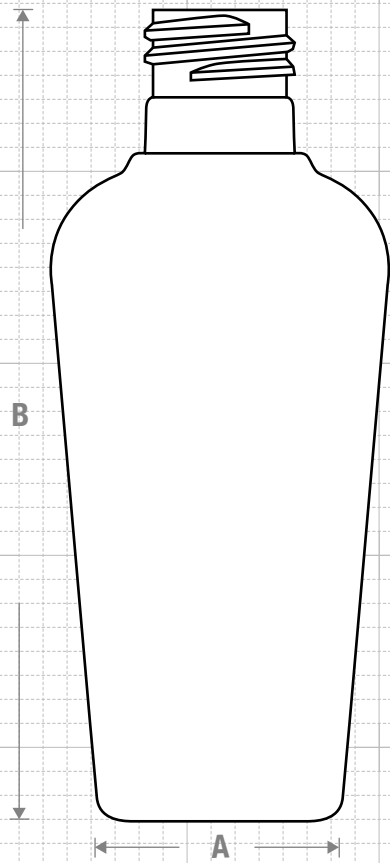

### SIDE VIEW

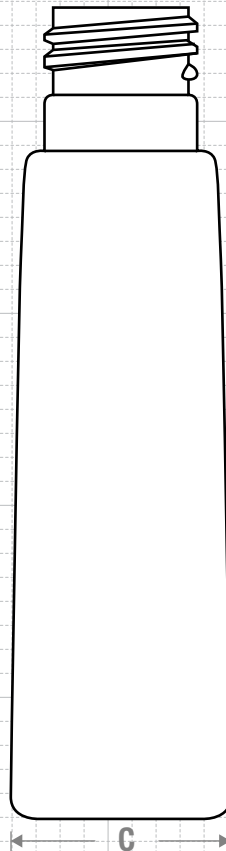

### NECK & THREAD DETAIL

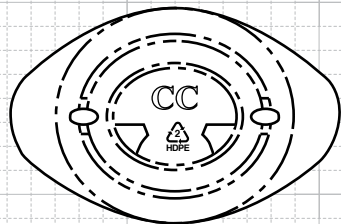
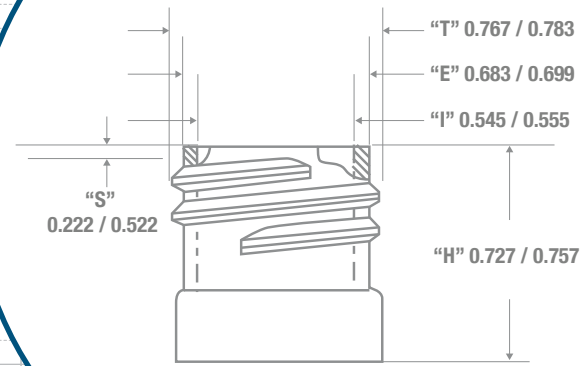

### BOTTOM VIEW

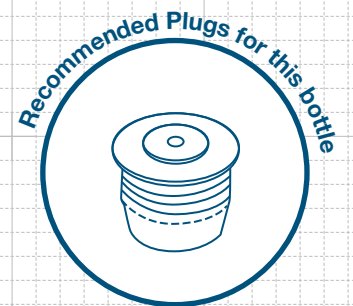
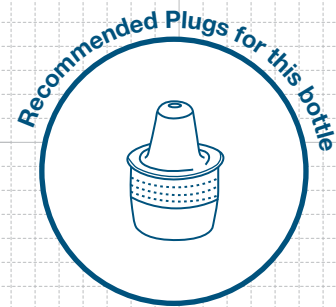

### FRICION FIT



**CLASSIC CONTAINERS INC**  
1700 S. Hellman Ave.  
Ontario, CA 91761  
Phone: 909-930-3610  
e-mail: info@classiccontainers.com  
www.classiccontainers.com

# PRINTING SPECIFICATIONS: 2 oz Vail Oval 20/415

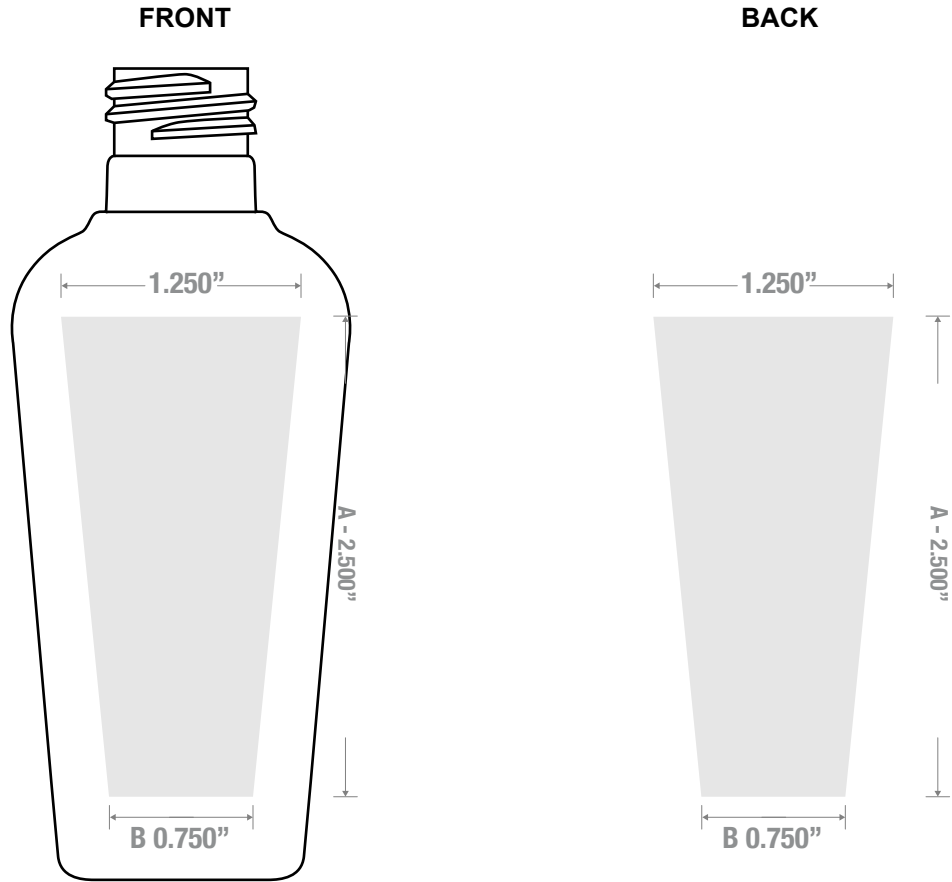

1700 S Hellman Ave, Ontario, California 91761  
Phone: (909) 930-3610 | Fax: (909) 930-3640  
e-mail: [info@classiccontainers.com](mailto:info@classiccontainers.com)  
[www.classiccontainers.com](http://www.classiccontainers.com)

**A - Total Height.**  
**B - Max. Decorating Area.**