



Drawing:
2 oz Cylinder Round 20/410
M-2

Stock Code:
0002000102000M2

Manufacturing Process:
Extrusion Blow Molding

Overflow Capacity:
65 - 74 ml (2.2 - 2.5 oz)

Gram Weight:
7.0 ± 1

Neck Finish:
20/410

Base Width (A):
1.370 ± 0.050

Overall Height (B):
3.697 ± 0.050

Max Print Area (Height):
2.500"

Max Print Area (Width):
4.063"

Case Pack: 928

Case Weight (lb): 16.4 ± 2.0

Cases Per Pallet: 25

Box Dimensions:
23 5/8 x 15 9/16 x 17

Stock Material:



CLASSIC CONTAINERS INC
1700 S. Hellman Ave.
Ontario, CA 91761
Phone: 909-930-3610
e-mail: info@classiccontainers.com
www.classiccontainers.com

FRONT VIEW

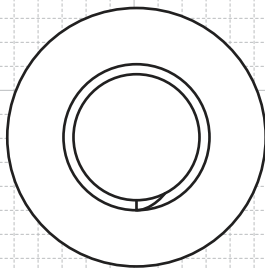
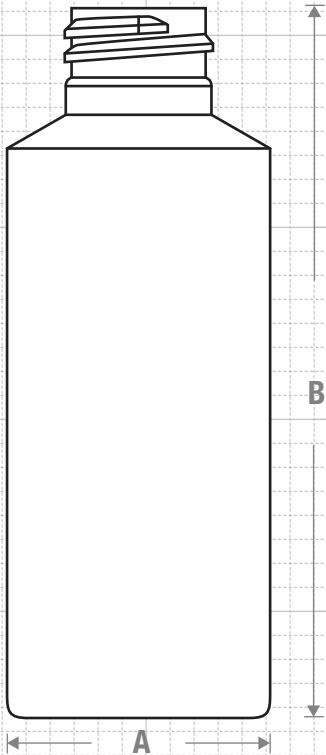

TOP VIEW

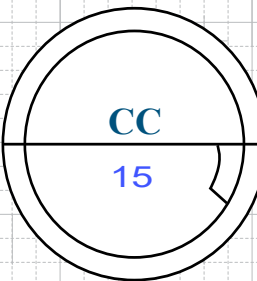
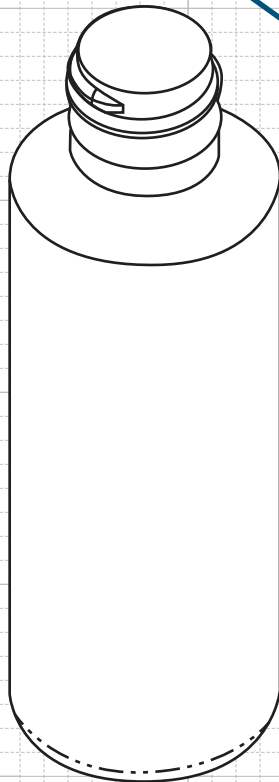

BOTTOM VIEW

NECK & THREAD DETAIL

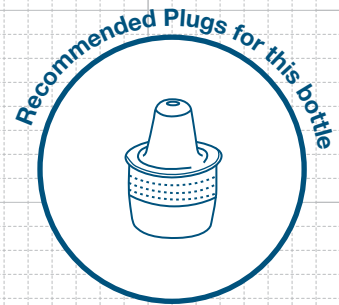
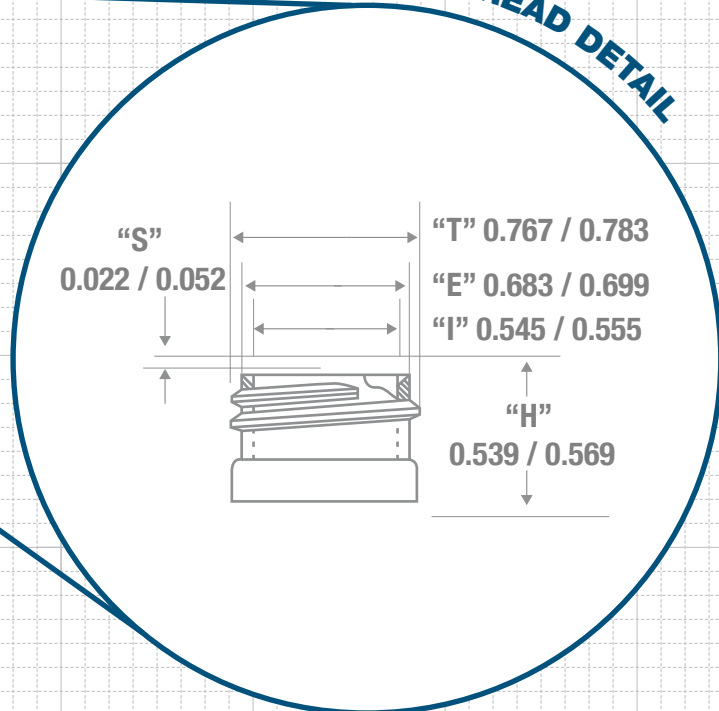
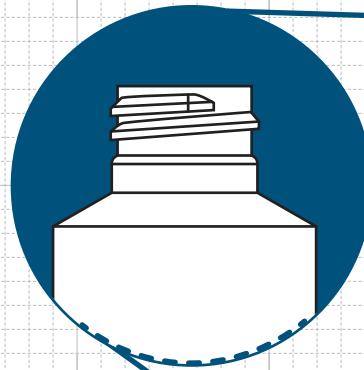

FRICION FIT



PRINTING SPECIFICATIONS: 2 oz CYLINDER ROUND 20/410 M-2

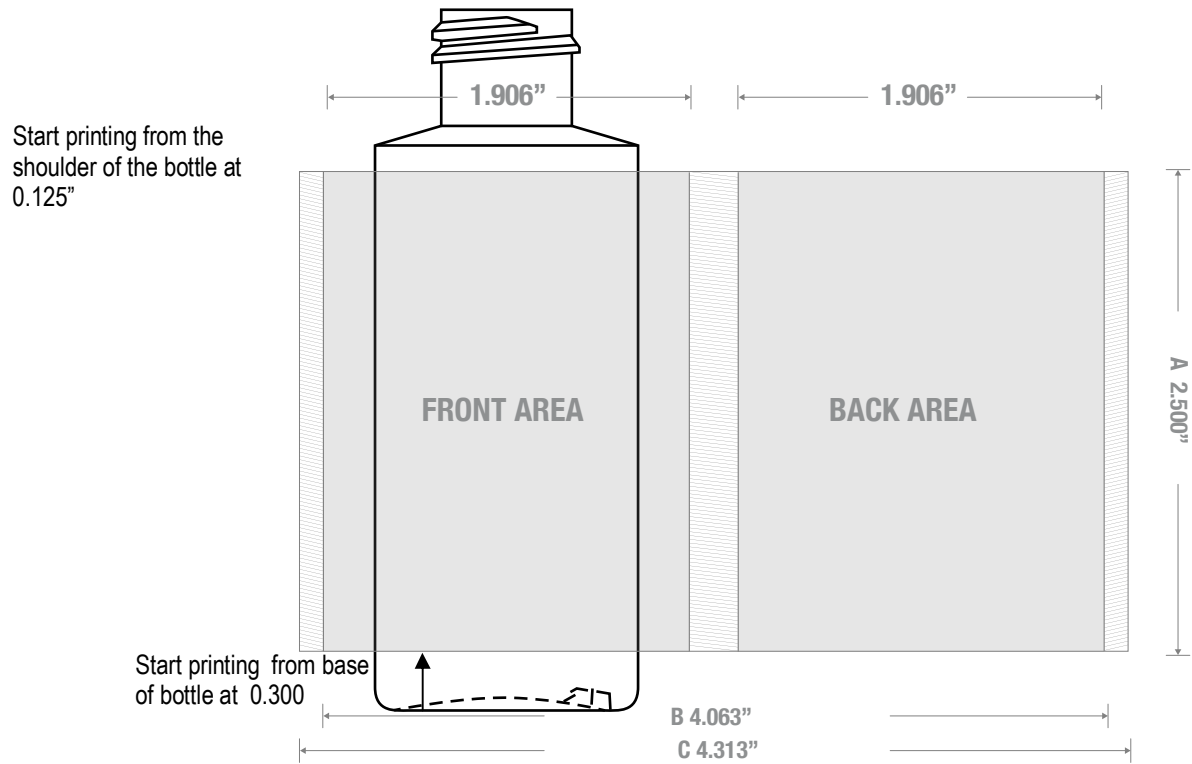

1700 S Hellman Ave, Ontario, California 91761
 Phone: (909) 930-3610 | Fax: (909) 930-3640
 e-mail: info@classiccontainers.com
www.classiccontainers.com

A - Total Height.
B - Max. Decorating Area.
C - Total bottle circumference.
 [Hatched Box] - Unprintable area.

LABELING SPECIFICATIONS: 2 oz CYLINDER ROUND 20/410 M-2



1700 S Hellman Ave, Ontario, California 91761
Phone: (909) 930-3610 | Fax: (909) 930-3640
e-mail: info@classiccontainers.com
www.classiccontainers.com

A - Total Height.
B - Total bottle circumference.