

FRONT VIEW

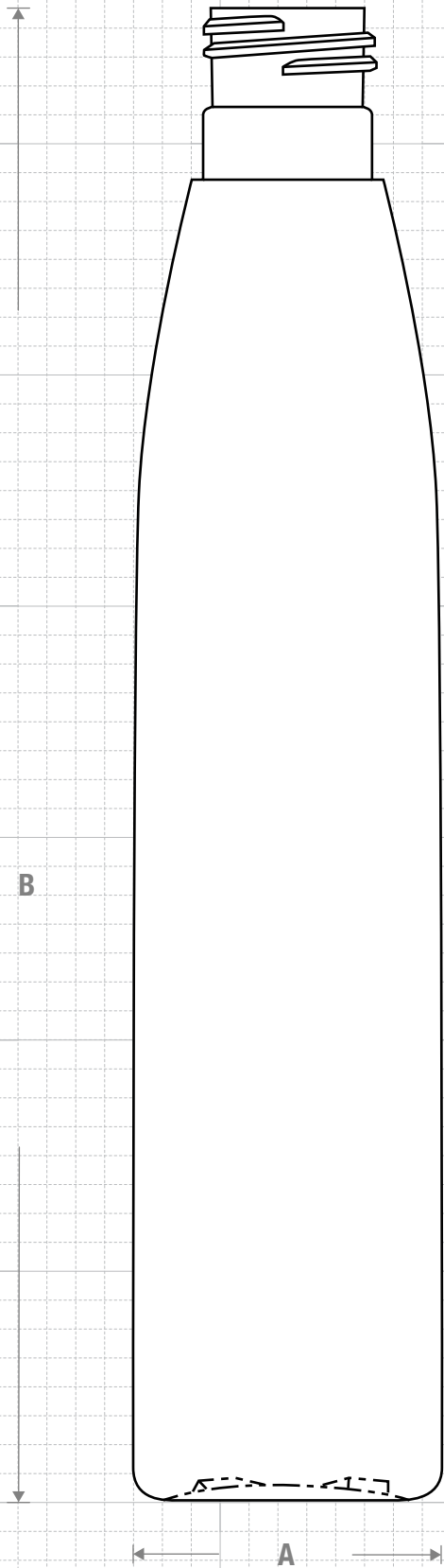

NECK & THREAD DETAIL

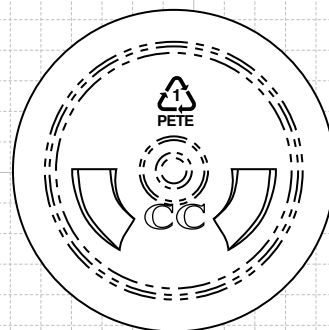
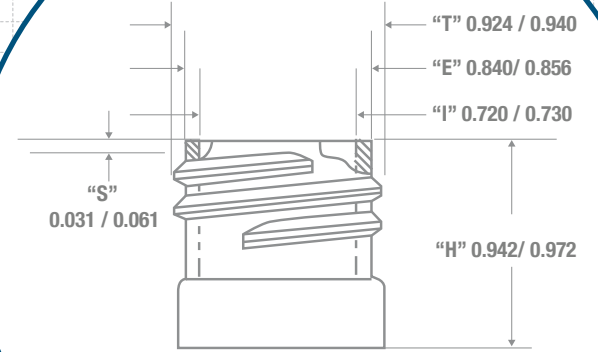

BOTTOM VIEW

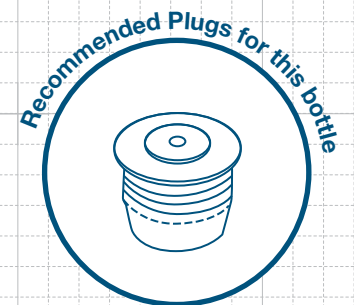

FRICTION FIT

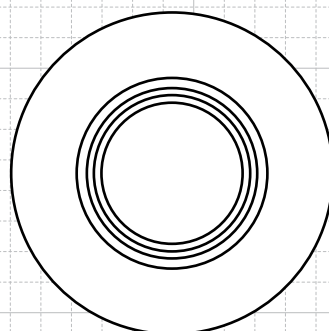

TOP VIEW



CLASSIC CONTAINERS INC
 1700 S. Hellman Ave.
 Ontario, CA 91761
 Phone: 909-930-3610
 e-mail: info@classiccontainers.com
 www.classiccontainers.com

Drawing:
250 ml Evolution Slim 24/415

Gram Weight:
23 ± 1

Max Print Area (Height):
4.740"

Cases Per Pallet: **16**

Stock Code:
025000470250000

Neck Finish:
24/415

Max Print Area (Width):
5.430"

Box Dimensions:
24 7/16 x 18 1/2 x 23

Manufacturing Process:
Stretch Blow Molding

Base Width (A):
1.805 ± 0.050

Case Pack: **391**

Stock Material:



Overflow Capacity:
254 - 271 ml (8.6 - 9.2 oz)

Overall Height (B):
8.207 ± 0.050

Case Weight (lb): **22.7 ± 0.9**

Rev #2 03/2016

Drawing not exactly to size.