



FRONT VIEW



Drawing:
1 oz Cylinder Round Tall
20/410

Stock Code:
000100030217000

Manufacturing Process:
Stretch Blow Molding

Overflow Capacity:
35.4 - 41.3 ml (1.15 - 1.35 oz)

Gram Weight:
6.0 ± 0.5

Neck Finish:
20/410

Base Width (A):
1.000 ± 0.050

Overall Height (B):
3.563 ± 0.050

Max Print Area (Height):
2.485"

Max Print Area (Width):
2.875"

Case Pack: 990

Case Weight (lb): 15.0± 1.0

Cases Per Pallet: 30

Box Dimensions:
23 5/8 x15 9/16 x17

Stock Material:



CLASSIC CONTAINERS INC
1700 S. Hellman Ave.
Ontario, CA 91761
Phone: 909-930-3610
e-mail: info@classiccontainers.com
www.classiccontainers.com

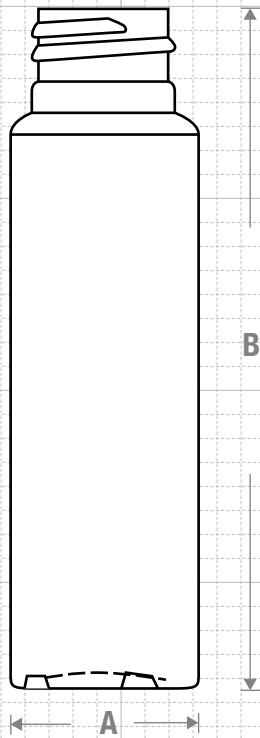

NECK & THREAD DETAIL

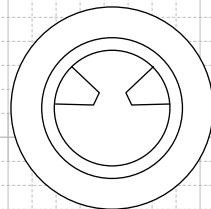
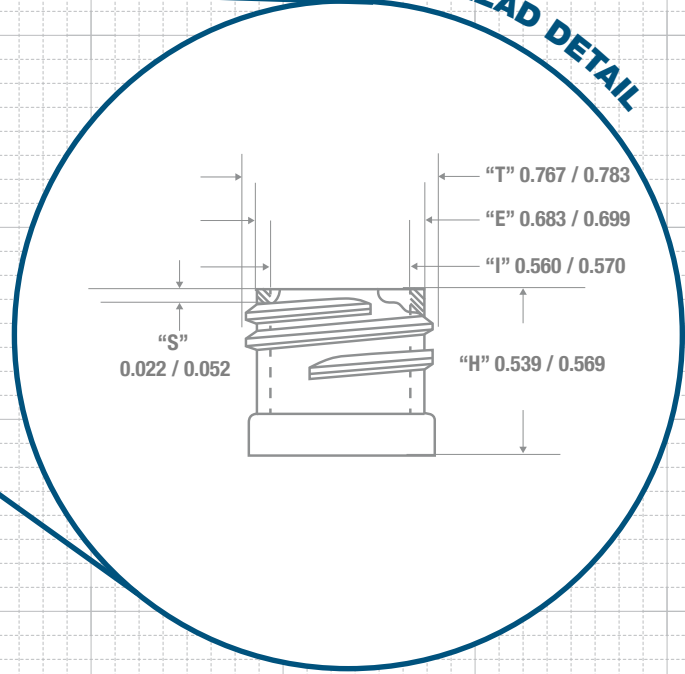

BOTTOM VIEW

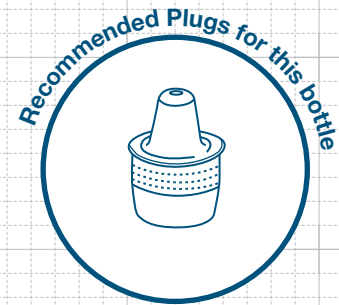
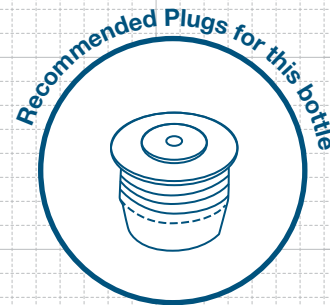

FRICTION FIT

PRINTING SPECIFICATIONS: 1 OZ CYLINDER ROUND TALL 20/410

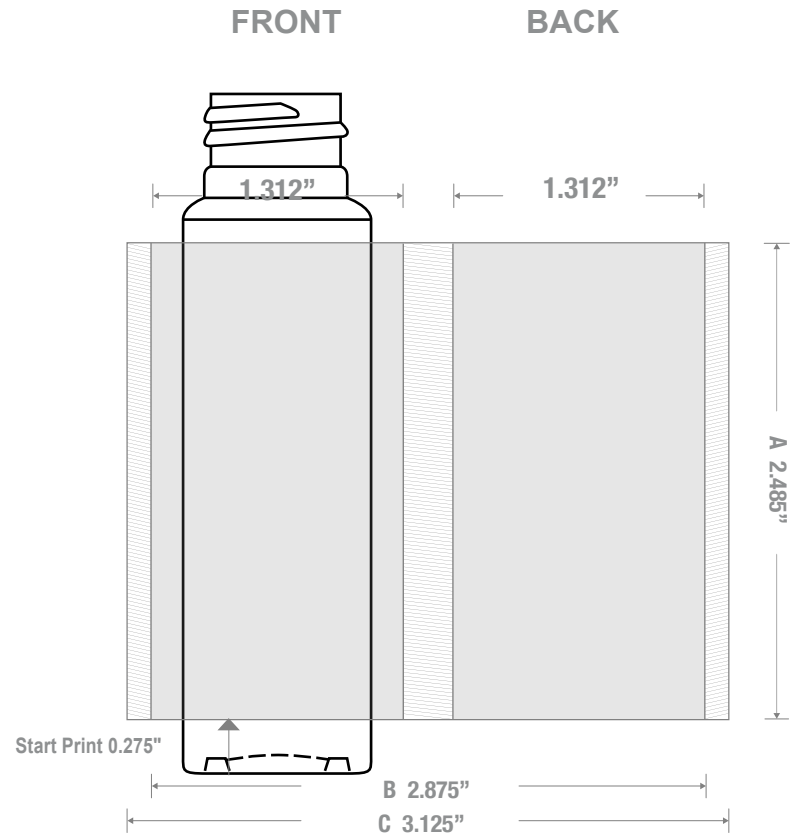

1700 S Hellman Ave, Ontario, California 91761
Phone: (909) 930-3610 | Fax: (909) 930-3640
e-mail: info@classiccontainers.com
www.classiccontainers.com

A - Total Height.
B - Max. Decorating Area.
C - Total bottle circumference.
☒ - Unprintable area.

LABELING SPECIFICATIONS: 1 OZ CYLINDER ROUND TALL 20/410

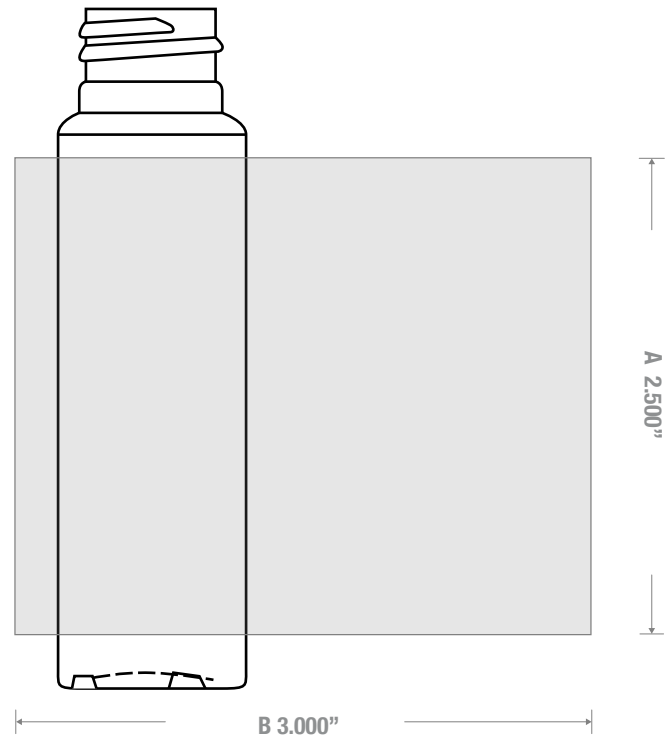

1700 S Hellman Ave, Ontario, California 91761
Phone: (909) 930-3610 | Fax: (909) 930-3640
e-mail: info@classiccontainers.com
www.classiccontainers.com

A - Total Height.
B - Total bottle circumference.