

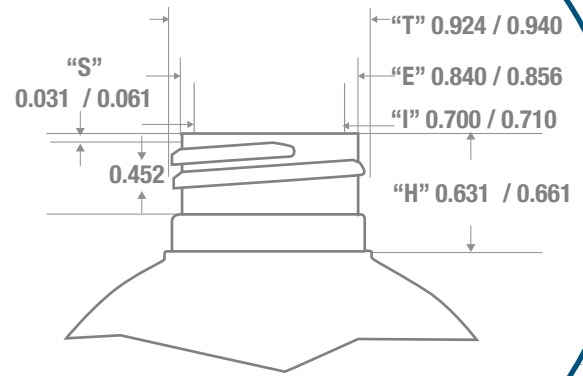

NECK & THREAD DETAIL

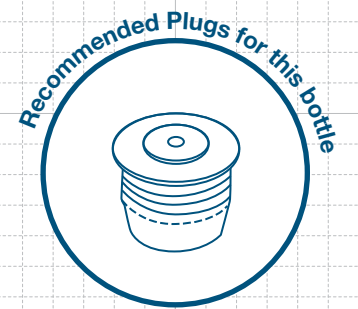

FRONT VIEW

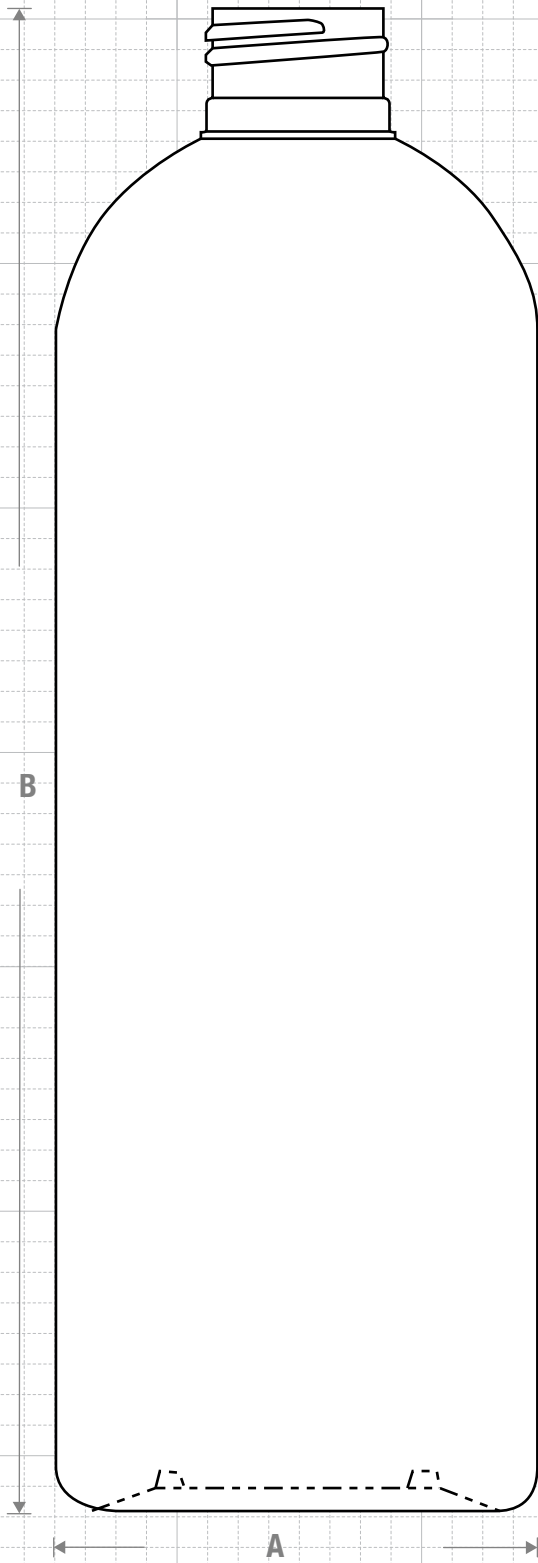

FRICITION FIT

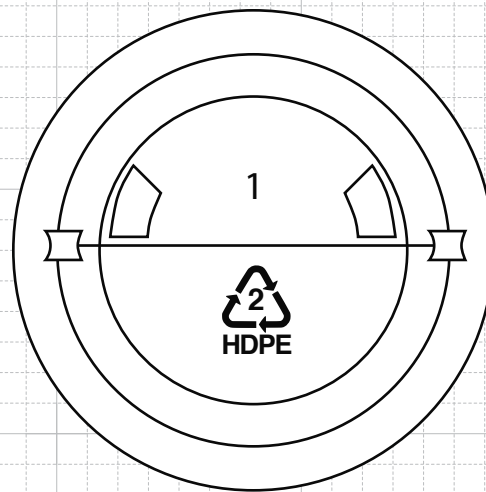

BOTTOM VIEW



CLASSIC CONTAINERS INC
 1700 S. Hellman Ave.
 Ontario, CA 91761
 Phone: 909-930-3610
 e-mail: info@classiccontainers.com
 www.classiccontainers.com

Drawing:
16 oz Royalty Round 24/410

Gram Weight:
32.5 ± 2

Max Print Area (Height):
5.500"

Cases Per Pallet: **16**

Stock Code:
001600040240000

Neck Finish:
24/410

Max Print Area (Width):
7.500"

Box Dimensions:
24 7/16 x 18 1/2 x 23

Manufacturing Process:
Extrusion Blow Molding

Base Width (A):
2.500 ± 0.050

Case Pack: **231**

Stock Material:



Overflow Capacity:
496 - 519 ml (16.8 - 17.6 oz)

Overall Height (B):
7.660 ± 0.050

Case Weight (lb): **19.5 ± 1.0**

Rev # 4 08/2019 Drawing not exactly to size.

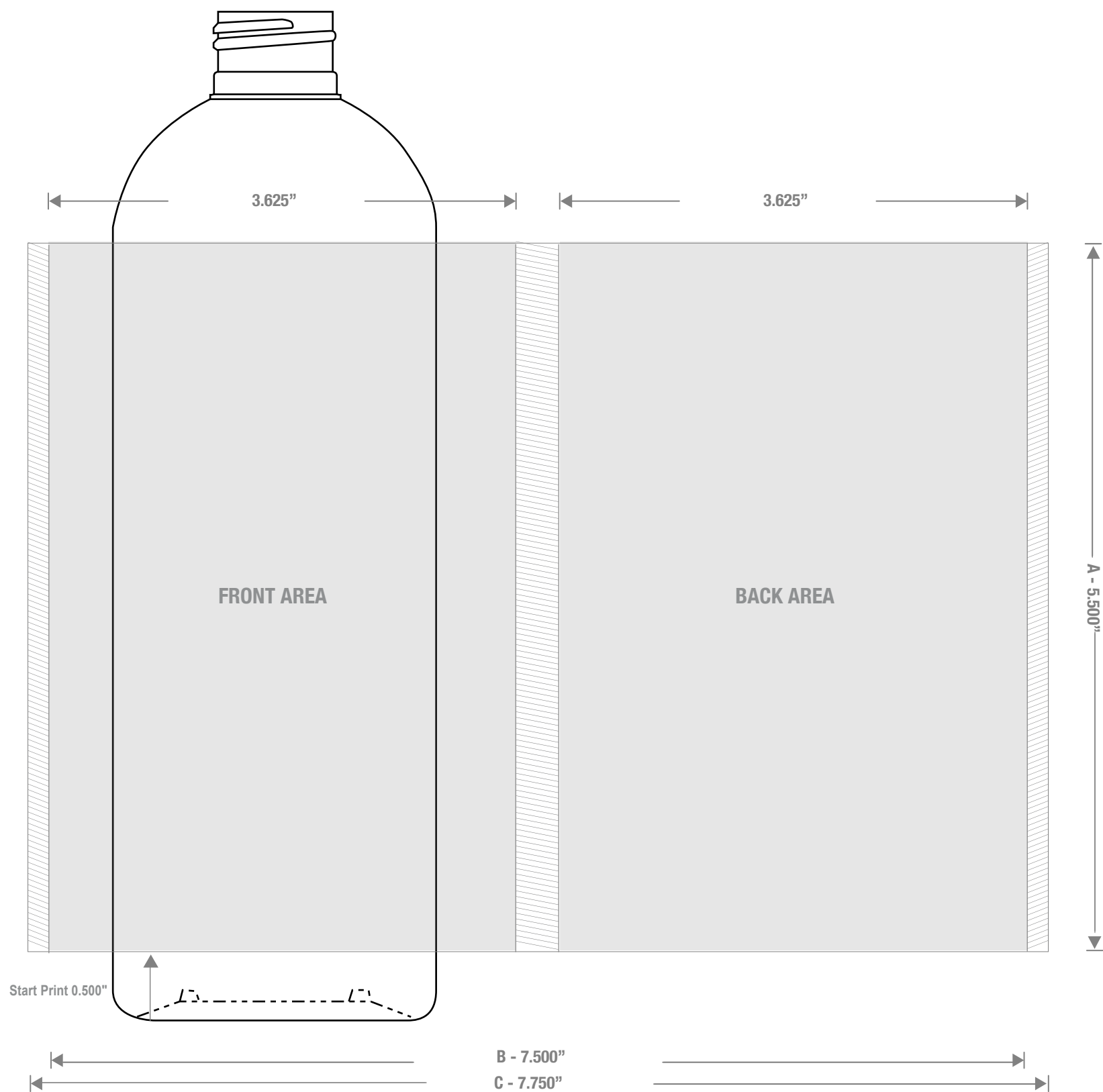

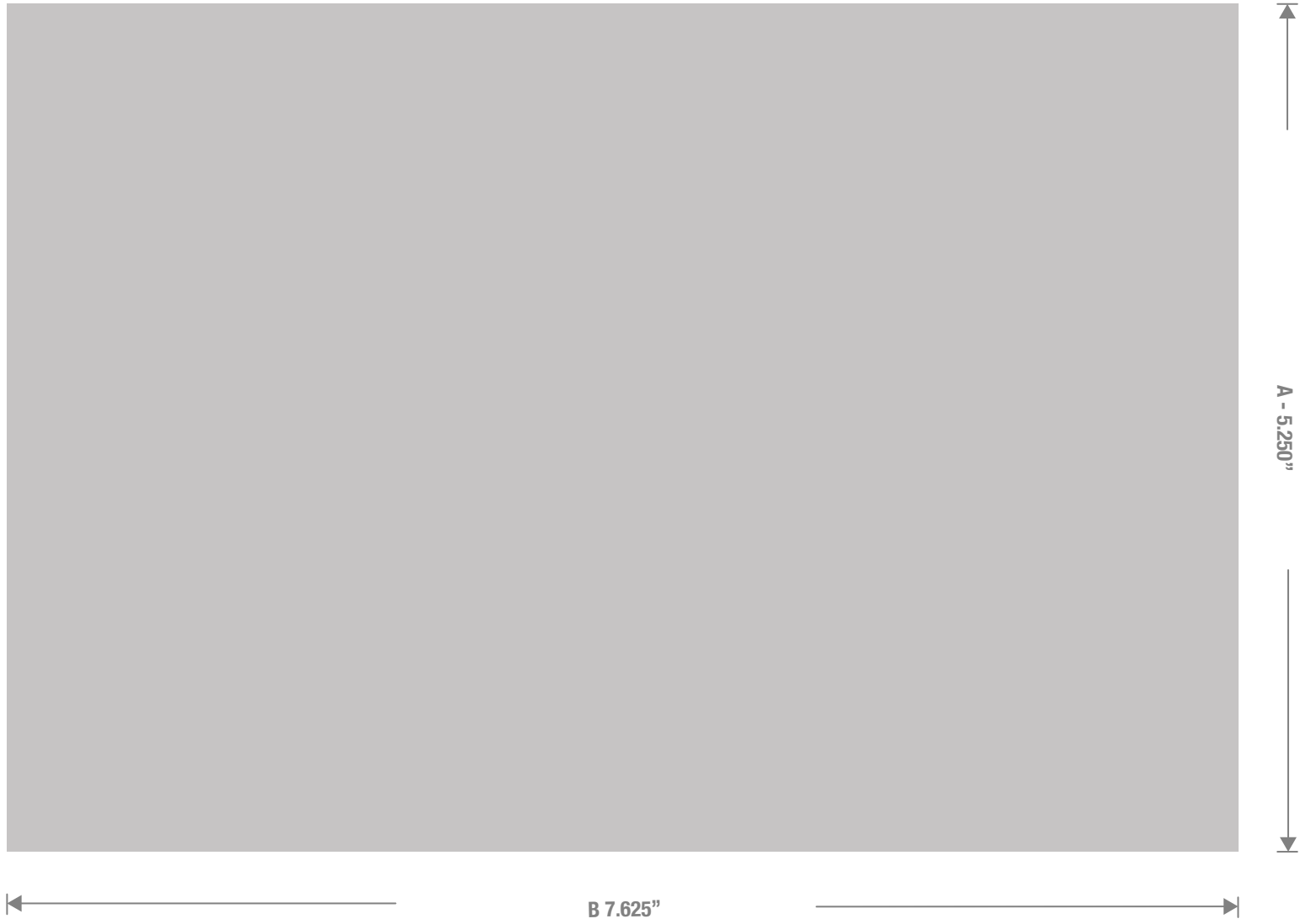

1700 S Hellman Ave, Ontario, California 91761
Phone: (909) 930-3610 | Fax: (909) 930-3640
e-mail: info@classiccontainers.com
www.classiccontainers.com

A - Total Height.
B - Total bottle circumference.