

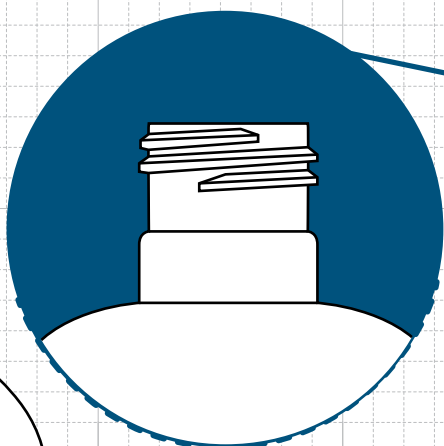

FRONT VIEW

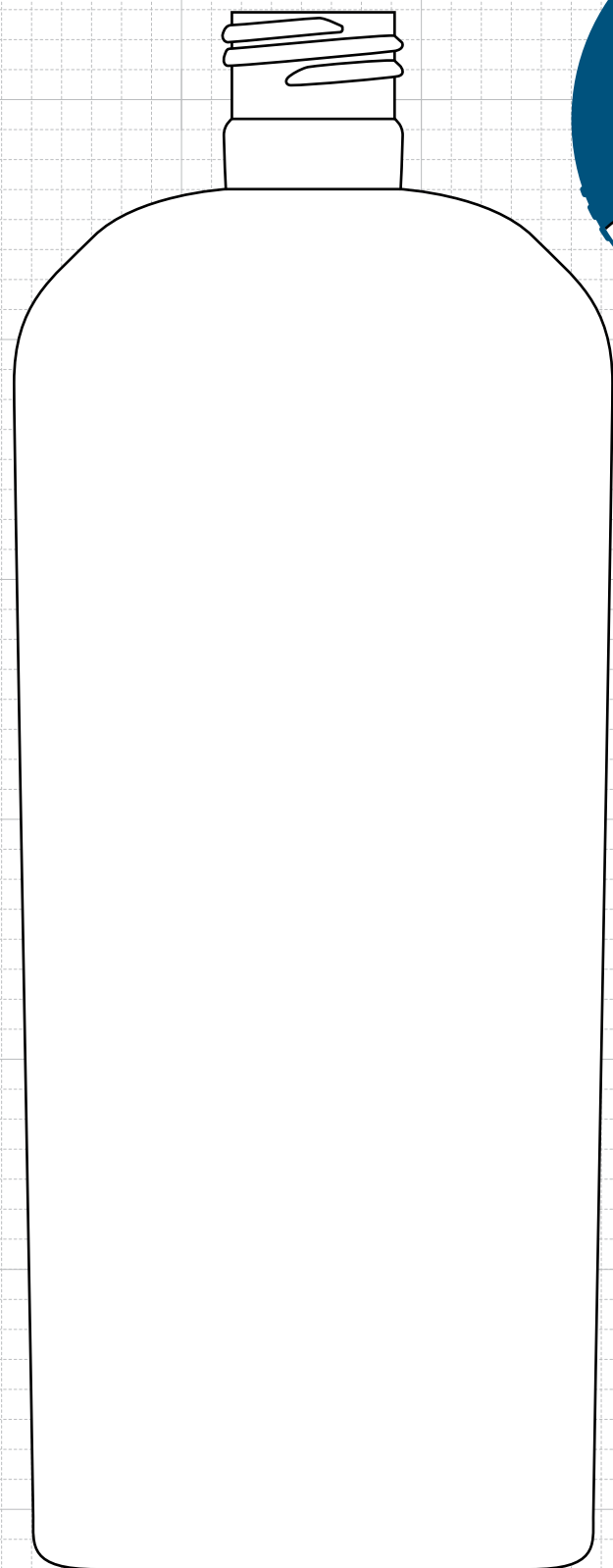

NECK & THREAD DETAIL

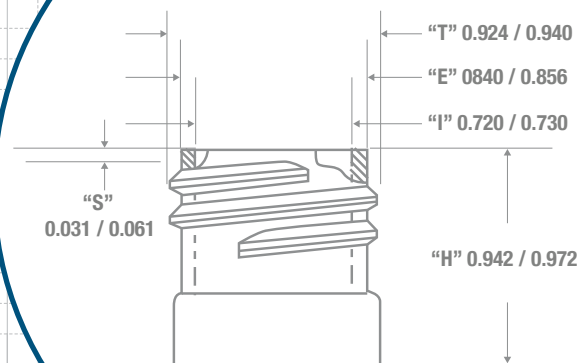

SIDE VIEW

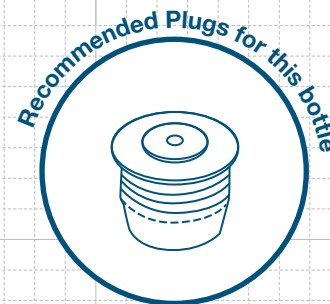
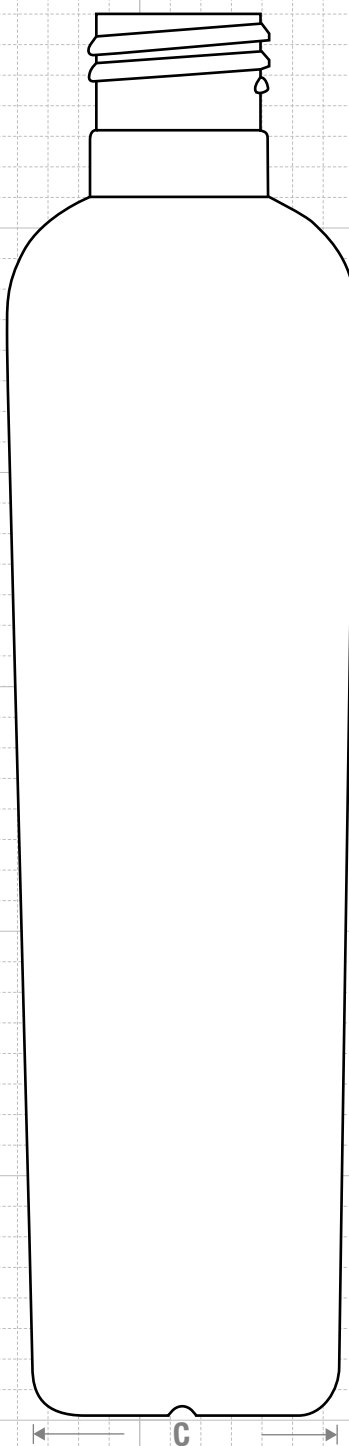

FRICION FIT

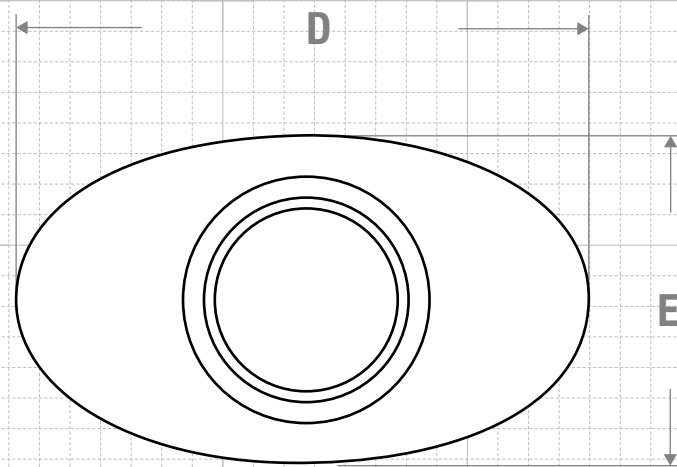

TOP VIEW

D Shoulder Width: 3.235 ± 0.050
E Shoulder Depth: 1.890 ± 0.050

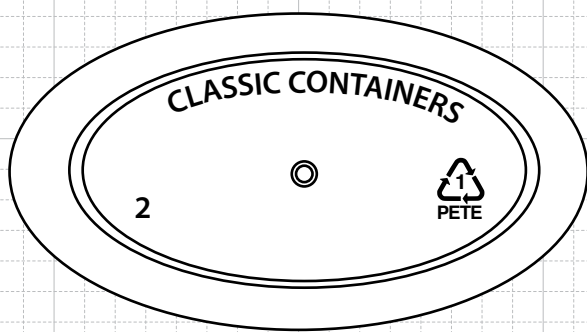

BOTTOM VIEW



CLASSIC CONTAINERS INC
1700 S. Hellman Ave.
Ontario, CA 91761
Phone: 909-930-3610
e-mail: info@classiccontainers.com
www.classiccontainers.com

Drawing:
16 oz Classic Oval 24/415

Gram Weight:
36 ± 1

Max Print Area (Height):
5.750"

Cases Per Pallet: **16**

Stock Code:
001600230251700

Neck Finish:
24/415

Max Print Area (Width):
2.062"

Box Dimensions:
24 7/16 x 18 1/2 x 23

Manufacturing Process:
Stretch Blow Molding

Base Width (A) Base Deep (C):
3.010 ± 0.050 1.665 ± 0.050

Case Pack: **196**

Stock Material:



Overflow Capacity:
487 - 510 ml (16.5 - 17.3 oz)

Overall Height (B):
8.180 ± 0.050

Case Weight (lb): **18.5 ± 0.43**

Rev #2 03/2016

Drawing not exactly to size.

FRONT

BACK

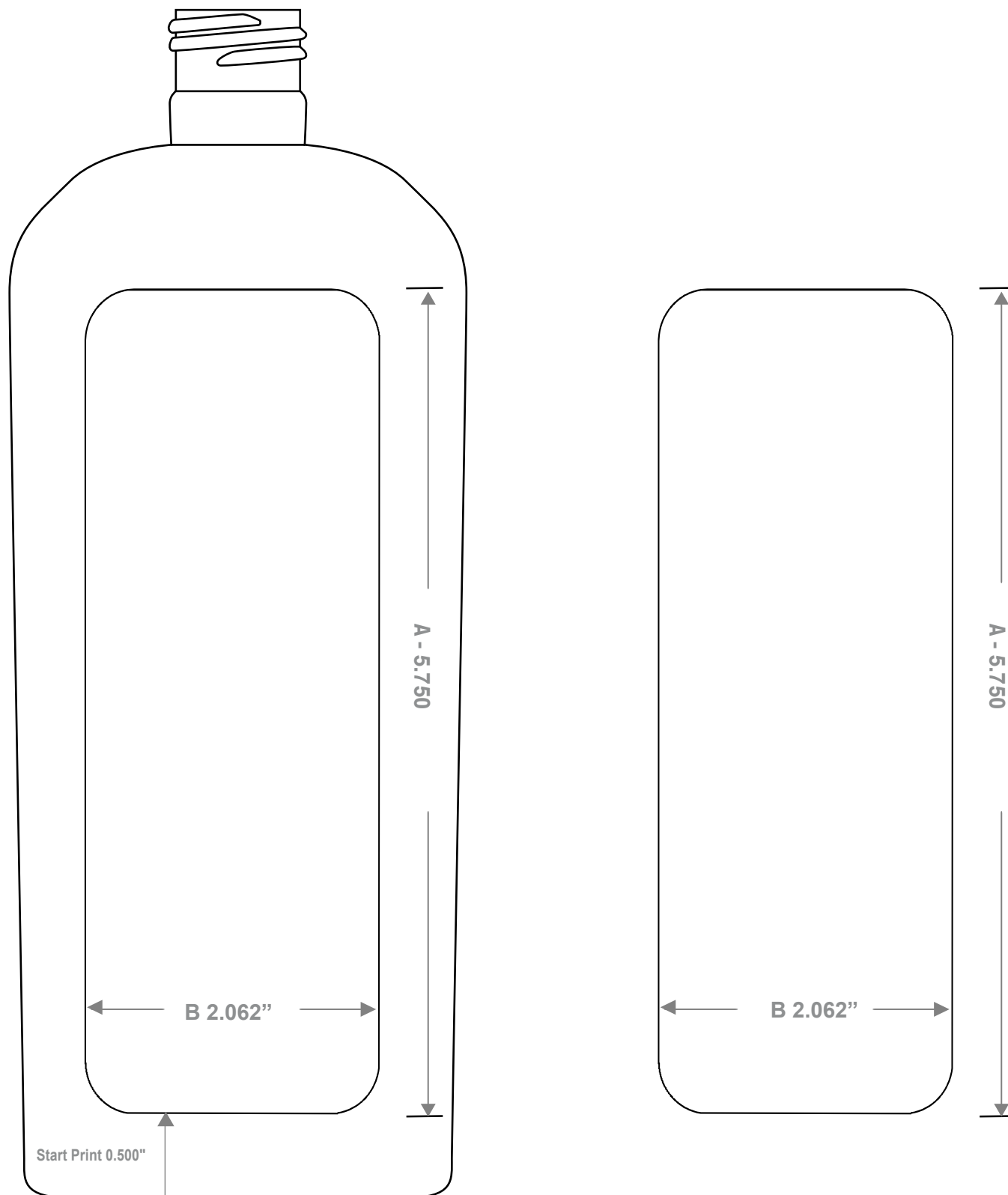

A - Total height.
B - max. decorating area.

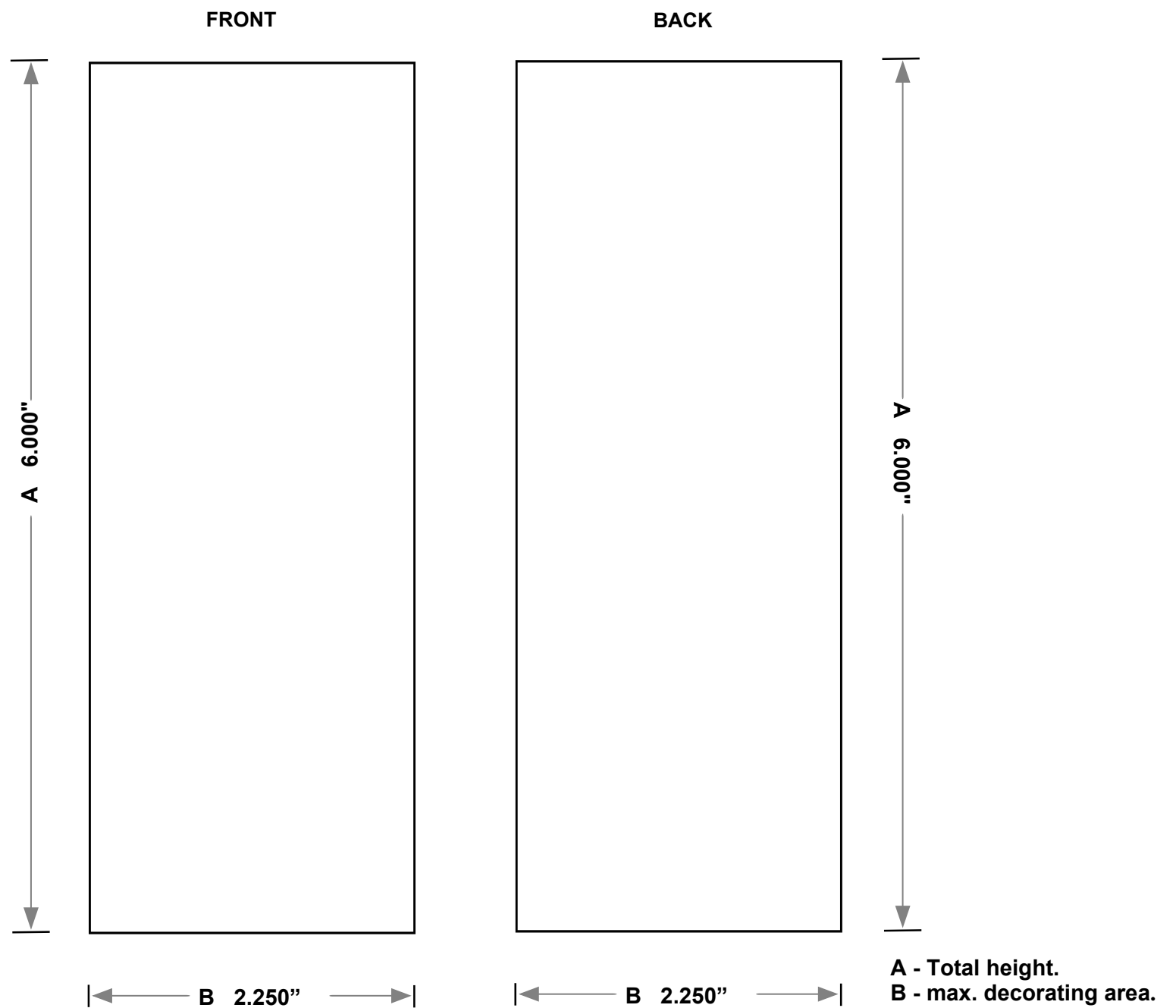

Rev. 2 31-Aug-18



1700 S Hellman Ave, Ontario, California 91761
Phone: (909) 930-3610 | Fax: (909) 930-3640
e-mail: info@classiccontainers.com
www.classiccontainers.com