

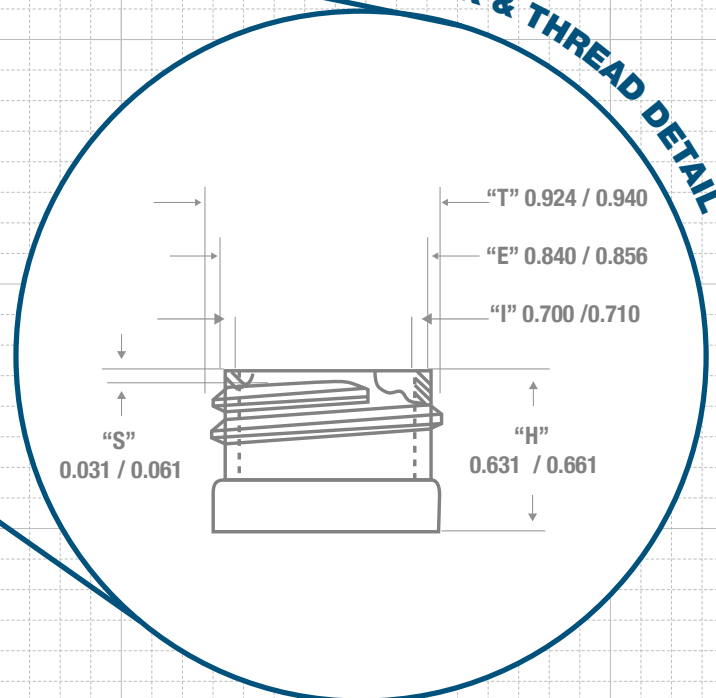

NECK & THREAD DETAIL

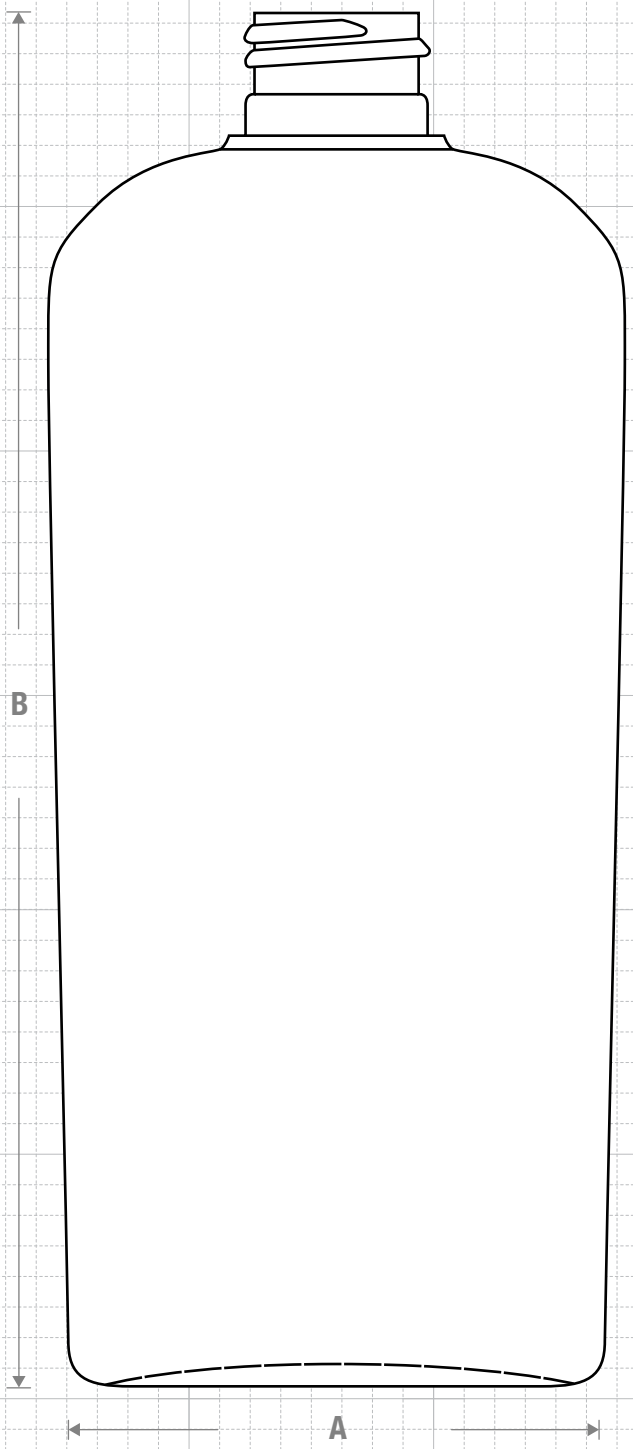

FRONT VIEW



SIDE VIEW

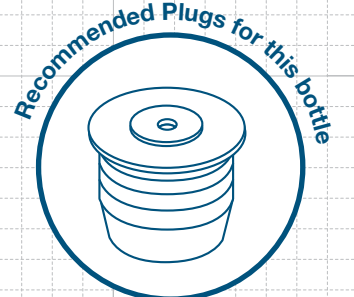
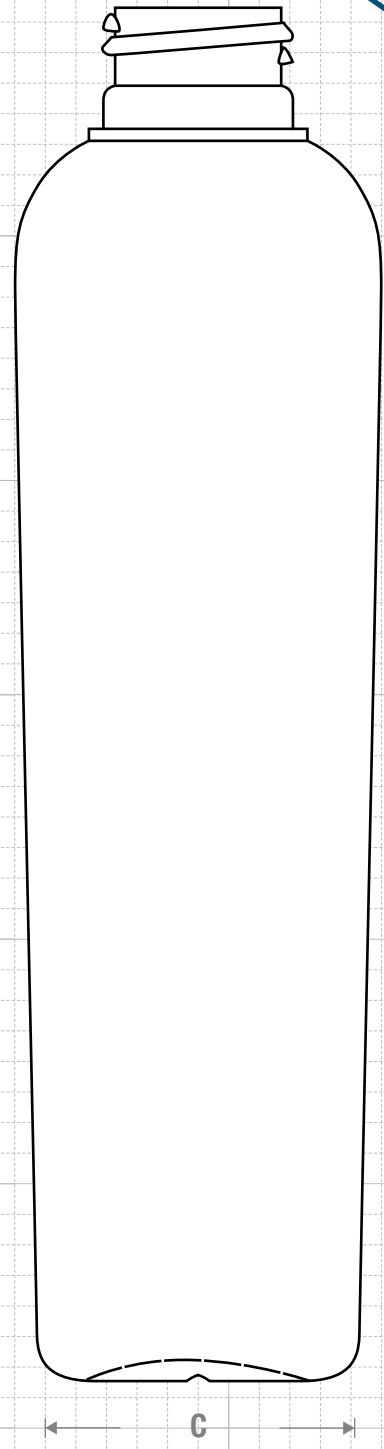

FRICTION FIT

TOP VIEW

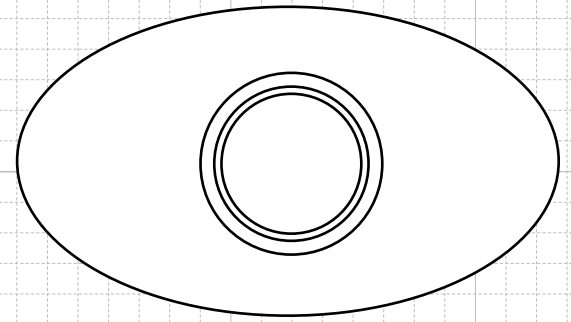

BOTTOM VIEW

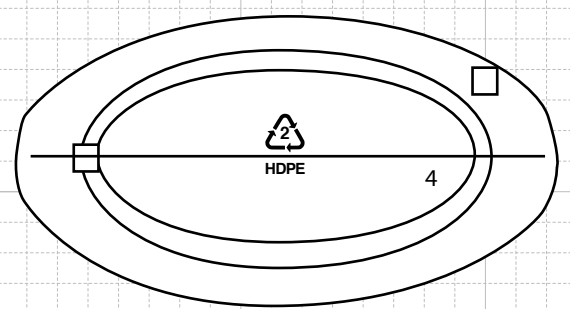

CLASSIC CONTAINERS INC
 1700 S. Hellman Ave.
 Ontario, CA 91761
 Phone: 909-930-3610
 e-mail: info@classiccontainers.com
 www.classiccontainers.com

Drawing: 12 oz Classic Oval 24/410	Gram Weight: 29 ± 2	Max Print Area (Height): 5.000"	Cases Per Pallet: 16
Stock Code: 001200230240000	Neck Finish: 24/410	Max Print Area (Width): 2.250"	Box Dimensions: 24 7/16 x 18 1/2 x 23
Manufacturing Process: Extrusion Blow Molding	Base Width (A): Base Deep (C) 2.820 ± 0.050 1.640 ± 0.050	Case Pack: 270	Stock Material:
Overflow Capacity: 386 - 404 ml (13.1 - 13.7 oz)	Overall Height (B): 7.140 ± 0.050	Case Weight (lb): 20.1 ± 1.2	Rev #4 - 02/2016 Drawing not exactly to size.

