

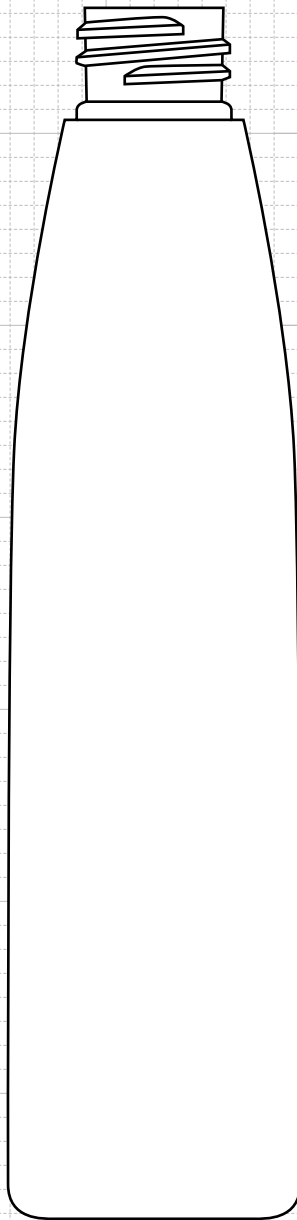

FRONT VIEW



Drawing:
125 ml Evolution Slim 20/410

Stock Code:
012500470200000

Manufacturing Process:
Stretch Blow Molding

Overflow Capacity:
130 - 142 ml (4.4 - 4.8 oz)

Gram Weight:
15 ± 1

Neck Finish:
20/410

Base Width (A):
1.475 ± 0.050

Overall Height (B):
6.304 ± 0.050

Max Print Area (Height):
3.490"

Max Print Area (Width):
4.430"

Case Pack: 426

Case Weight (lb): 16.2 ± 0.9

Cases Per Pallet: 25

Box Dimensions:
23 5/8 x 15 9/16 x 17

Stock Material:



CLASSIC CONTAINERS INC
1700 S. Hellman Ave.
Ontario, CA 91761
Phone: 909-930-3610
e-mail: info@classiccontainers.com
www.classiccontainers.com

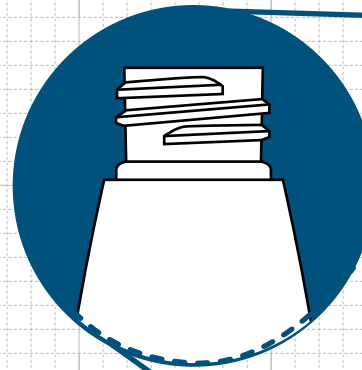

NECK & THREAD DETAIL

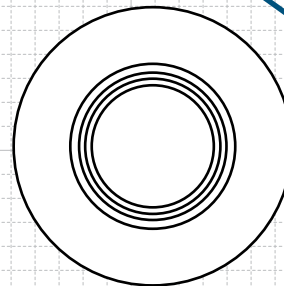
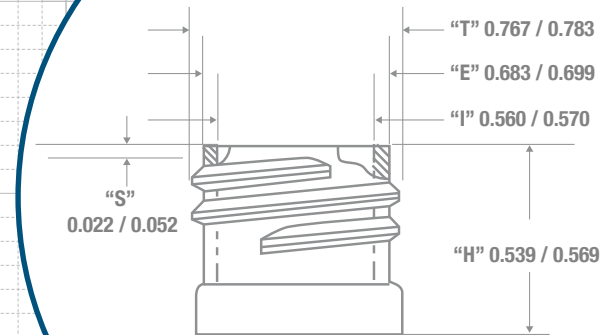

TOP VIEW

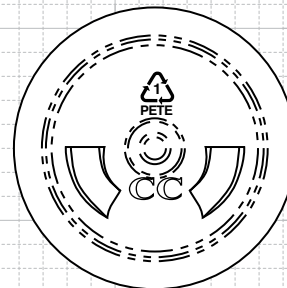

BOTTOM VIEW

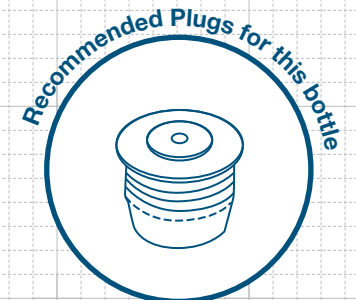
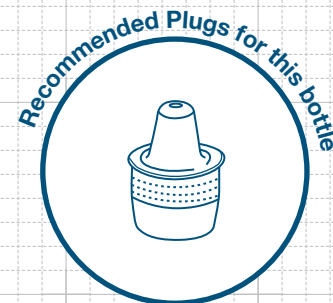

FRICION FIT